

# My Book<sup>®</sup>

World Edition<sup>™</sup>

User Manual

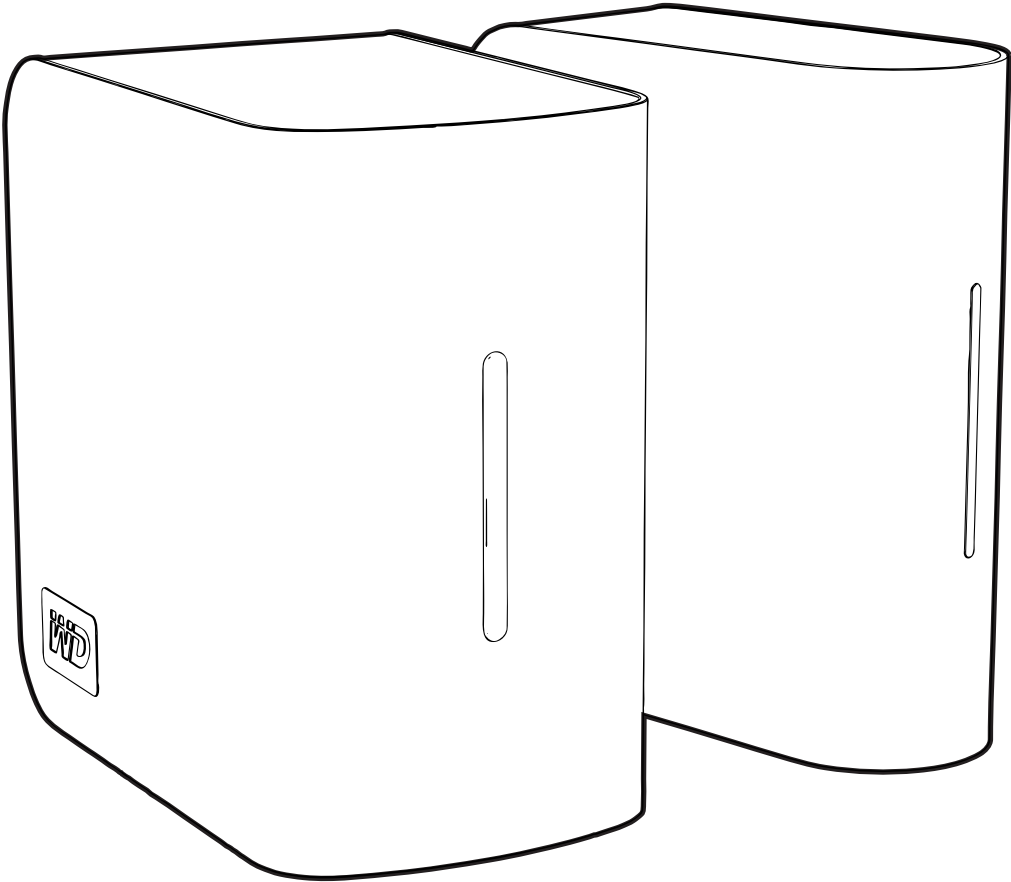

## Important Safety Instructions

1. Follow all warnings and instructions marked on the product.
2. Unplug this product from the wall outlet before cleaning. Do not use liquid cleaners or aerosol cleaners. Use a damp cloth for cleaning.
3. Do not use this product near any liquids.
4. Do not place this product on an unstable surface. The product may fall, causing serious damage to the product.
5. Do not drop the product.
6. Do not block the slots and openings on the back or bottom side of the chassis; to ensure proper ventilation and reliable operation of the product and to protect it from overheating, these openings must not be blocked or covered.
7. Operate this product only from the type of power indicated on the marking label. If you are not sure of the type of power available, consult your dealer or local power company.
8. Do not allow anything to rest on the power cord. Do not locate this product where persons will walk on the cord.
9. If an extension cord is used with this product, make sure that the total ampere rating of the equipment plugged into the extension cord does not exceed the extension cord ampere rating. Also, make sure that the total rating of all products plugged into the wall outlet does not exceed the fuse rating.
10. Never push objects of any kind into this product through the chassis slots as they may touch dangerous voltage points or short out parts that could result in a fire or electric shock.
11. Unplug this product from the wall outlet and refer servicing to qualified service personnel under the following conditions:
  - a When the power cord or plug is damaged or frayed.
  - b If liquid has been spilled on the product.
  - c If the product has been exposed to rain or water.
  - d If the product does not operate normally when the operating instructions are followed. Adjust only those controls that are covered by the operating instructions since improper adjustment may result in damage and require extensive work by a qualified technician to restore the product to normal condition.
  - e If the product has been dropped or the chassis has been damaged.
  - f If the product exhibits a distinct change in performance, indicating a need for service.
12. In accordance with workstation regulation standards, do not place this device in the visual field of the user due to the glossy front of the case.

# Table of Contents

---

## WD Service and Support

Registering Your WD Product . . . . .	1
---------------------------------------	---

---

## **1 Overview . . . . .2**

Introduction . . . . .	2
Drive Format . . . . .	2
Specifications . . . . .	3
Kit Contents . . . . .	4
Accessories . . . . .	4
System Requirements . . . . .	5
Pre-installation . . . . .	5
Recording Your WD Product Information . . . . .	6
System View . . . . .	7
Ports . . . . .	7
Reset Button . . . . .	7
Power Button . . . . .	8
Kensington Security Slot . . . . .	8
LED Indicators (Lights) . . . . .	9

---

## **2 My Book World Edition Basic Setup . . . . .10**

Step 1: Connect My Book World Edition to the Network . . . . .	10
Step 2: Access My Book World Edition on the Network . . . . .	11
Congratulations! . . . . .	19
My Book World Edition File Storage . . . . .	20

---

## **3 How to Back Up Computers on the Network . . . . .21**

WD Anywhere Backup . . . . .	21
Installing WD Anywhere Backup . . . . .	21
Configuring WD Anywhere Backup . . . . .	24

---

## **4 MioNet Remote Access . . . . .33**

Overview . . . . .	33
Remote Access Setup . . . . .	33
Using MioNet . . . . .	35

<b>5</b>	<b>How to Play/Stream Video, Music &amp; Photos . . . . .</b>	<b>36</b>
	Media Server Overview . . . . .	36
	Media Types Supported . . . . .	36
	Media Storage . . . . .	37
	Media Devices . . . . .	38
<b>6</b>	<b>Using iTunes with My Book World Edition . . . . .</b>	<b>44</b>
	iTunes Media Server Overview . . . . .	44
	Media Types Supported . . . . .	44
	Storing Content . . . . .	44
	Streaming Audio in iTunes . . . . .	44
<b>7</b>	<b>Connecting a USB Hard Drive . . . . .</b>	<b>46</b>
	Copy Manager . . . . .	46
<b>8</b>	<b>Using WD Discovery . . . . .</b>	<b>47</b>
	Mapping a Network Drive . . . . .	47
	Browse Network Shares (Windows only) . . . . .	50
	Desktop Shortcut Creation (Windows only) . . . . .	52
<b>9</b>	<b>Network Storage Manager . . . . .</b>	<b>53</b>
	Configuring My Book World Edition . . . . .	53
	Network Storage Manager Features . . . . .	59
	User Interface Overview . . . . .	60
	Basic Mode . . . . .	62
	Advanced Mode . . . . .	71
<b>10</b>	<b>Accessing Data via FTP . . . . .</b>	<b>117</b>
<b>11</b>	<b>Scheduled Downloads . . . . .</b>	<b>118</b>
	Downloader Features . . . . .	119
<b>12</b>	<b>Copy Manager . . . . .</b>	<b>123</b>
	Connect a USB hard drive . . . . .	123
	Accessing Copy Manager . . . . .	123
	NAS to USB Copy . . . . .	124
	USB to NAS Copy . . . . .	125

---

<b>13</b>	<b>Replacing a Drive (My Book World Edition II) . . .</b>	<b>128</b>
<hr/>		
<b>14</b>	<b>Troubleshooting . . . . .</b>	<b>132</b>
<hr/>		
<b>15</b>	<b>Appendix. . . . .</b>	<b>138</b>
	Regulatory Compliance. . . . .	138
	Environmental Compliance (China). . . . .	139
	Warranty Information. . . . .	139
	GNU General Public License (“GPL”). . . . .	140
	WD Service and Support . . . . .	141
<hr/>		
	<b>Index . . . . .</b>	<b>142</b>

## WD Service and Support

Should you encounter any problem, please give us an opportunity to address it before returning this product. Most technical support questions can be answered through our knowledge base or e-mail support service at [support.wdc.com](mailto:support.wdc.com). If the answer is not available or, if you prefer, please contact WD at the best telephone number shown below.

Your product includes 30 days of free telephone support during the warranty period. This 30-day period starts on the date of your first telephone contact with WD technical support. E-mail support is free for the entire warranty period and our extensive knowledge base is available 24/7. To help us keep you informed of new features and services, remember to register your product online at <https://www.wdc.com/register>.

### Accessing Online Support

Visit our product support website at [support.wdc.com](http://support.wdc.com) and choose from these topics:

- **Downloads** - Download drivers, software, and updates for your WD product.
- **Registration** - Register your WD product to get the latest updates and special offers.
- **Warranty & RMA Services** - Get Warranty, Product Replacement (RMA), RMA Status, and Data Recovery Information.
- **Knowledge Base** - Search by keyword, phrase, or answer ID.
- **Installation** - Get online installation help for your WD product or software.

### Contacting WD Technical Support

When contacting WD for support, have your WD product serial number, system hardware, and system software versions available.

North America		Asia Pacific	
English	800.ASK.4WDC (800.275.4932)	Australia	1 800 42 9861
Spanish	800.832.4778	China	800 820 6682/+65 62430496
		Hong Kong	+800 6008 6008
		India	1 800 11 9393 (MNTL)/1 800 200 5789 (Reliance) 011 26384700 (Pilot Line)
<b>Europe (toll free)*</b>	00800 ASK4 WDEU (00800 27549338)	Indonesia	+803 852 9439
		Japan	00 531 650442
		Korea	02 703 6550
<b>Europe</b>	+31 880062100	Malaysia	+800 6008 6008/1 800 88 1908/+65 62430496
<b>Middle East</b>	+31 880062100	Philippines	1 800 1441 0159
<b>Africa</b>	+31 880062100	Singapore	+800 6008 6008/+800 608 6008/+65 62430496
		Taiwan	+800 6008 6008/+65 62430496

\* Toll free number available in the following countries: Austria, Belgium, Denmark, France, Germany, Ireland, Italy, Netherlands, Norway, Spain, Sweden, Switzerland, United Kingdom.

### Registering Your WD Product

Your WD product includes 30 days of free technical support during the applicable warranty period for your product. The 30-day period commences on the date of your first telephone contact with WD technical support. Register online at [register.wdc.com](http://register.wdc.com).

**1**

# Overview

## Introduction

Congratulations on your purchase of My Book® World Edition™, a high-speed network attached storage system with a space-saving footprint. This system is equipped with one or two WD drives using WD GreenPower™ technology for efficient cooling and power saving. The high-speed interface delivers high performance for small offices or home users and is ideal for backing up and sharing files over the internet.

This user manual provides step-by-step installation instructions and other important information regarding your WD product. For the latest WD product information and news, visit our website at [www.westerndigital.com](http://www.westerndigital.com).

## Drive Format

My Book World Edition is a single-drive configuration. My Book World Edition II is a dual-drive system that is pre-configured to RAID 1 (Mirrored) mode for extra data protection. If one drive fails in RAID 1, the system will still run, and your data will be preserved. You can replace the failed drive and restore the system. My Book World Edition II also supports RAID 0 (Striped) mode for maximum capacity and accelerated performance. For more information, including instructions on changing the RAID configuration for My Book World Edition II, see “Volumes and RAID Management” on page 93.

## Specifications

Ethernet	High performance (10/100/1000) Gigabit Ethernet connection
Internal hard drive	WD 3.5-inch SATA hard drive
External USB storage file systems supported	NTFS, FAT/, HFS+
Supported protocols	HTTP, HTTPS, CIFS/SMB, NFS, FTP, AFP
I/O ports	<ul style="list-style-type: none"> <li>▪ USB 2.0 port (for USB device expansion)</li> <li>▪ Ethernet (RJ-45) port</li> </ul>
Supported clients	<ul style="list-style-type: none"> <li>▪ Windows® XP/Vista (latest service packs required)*</li> <li>▪ Mac OS® X Tiger® or Leopard®</li> </ul>
Physical dimensions	<p>My Book World Edition</p> <ul style="list-style-type: none"> <li>▪ Length: 6.5 in (165 mm)</li> <li>▪ Width: 5.4 in (137 mm)</li> <li>▪ Height: 2.1 in (54 mm)</li> <li>▪ Weight: 2.6 lb (1.18 kg)</li> </ul> <p>My Book World Edition II</p> <ul style="list-style-type: none"> <li>▪ Length: 6.5 in (165 mm)</li> <li>▪ Width: 6.0 in (152 mm)</li> <li>▪ Height: 3.8 in (97 mm)</li> <li>▪ Weight: 5.5 lb (2.5 kg)</li> </ul>
Power consumption	<ul style="list-style-type: none"> <li>▪ Input voltage: 100V to 240V AC</li> <li>▪ Input frequency: 50 to 60 Hz</li> </ul>
Environmental	<ul style="list-style-type: none"> <li>▪ Operating temperature: 5 to 35 °C (41 to 95 °F)</li> <li>▪ Non-operating temperature: -20 to 65°C (-4 to 149 °F)</li> </ul>

# Kit Contents

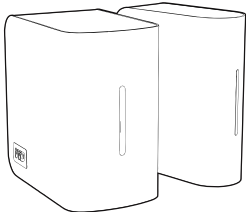

Network storage system

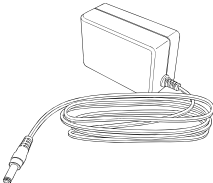

AC adapter\*

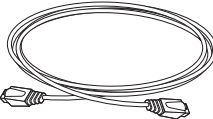

Ethernet cable



Installation CD with application software and user manual

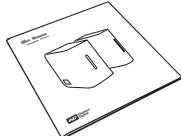

Quick Install Guide

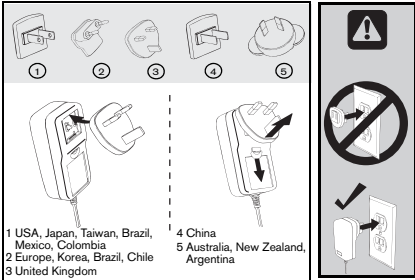

or

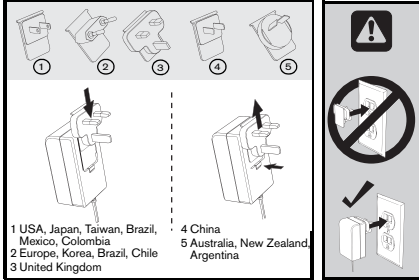

\*Global AC adapter configurations

# Accessories

Visit [shopwd.com](http://shopwd.com) (U.S. only) to view additional accessories like cables, power supplies, additional hard drives, and drive mounting rails for this product. Outside the U.S., visit [support.wdc.com](http://support.wdc.com).

## System Requirements

*Note:* For optimum performance, the following system and network requirements are recommended. Compatibility may vary depending on user's hardware configuration and operating system.



.....  
**Important:** For highest performance and reliability, it is recommended that you install the latest updates and service pack (SP). For Macintosh, go to the **Apple** menu and select **Software Update**. For Windows, go to the **Start** menu and select **Windows Update**.

### Client computer

- Ethernet connection (network adapter, router, switch, or hub)
- Operating system
  - Windows XP/Vista
  - Mac OS X Tiger or Leopard
- Web browser (Internet Explorer 6.0 SP1 and later on Windows platforms supported by this product, Safari 2.0 and later on Mac platforms supported by this product, Firefox 2.0 and later on supported Windows and Mac platforms)
- Adobe Flash ActiveX 9 or higher (required for WD Discovery™)

### Local network

- Router/switch (Gigabit required to maximize performance)

### Wide Area Network

- Broadband internet connection required for remote access using MioNet

## Pre-installation

Before unpacking and installing the system, select a suitable site for the system for maximum efficiency. Place the device in a site that is:

- Near a grounded power outlet
- Clean and dust free
- On a stable surface free from vibration
- Well-ventilated and away from sources of heat
- Secluded from electromagnetic fields from electrical devices such as air conditioners, radio, TV transmitters.

## Recording Your WD Product Information



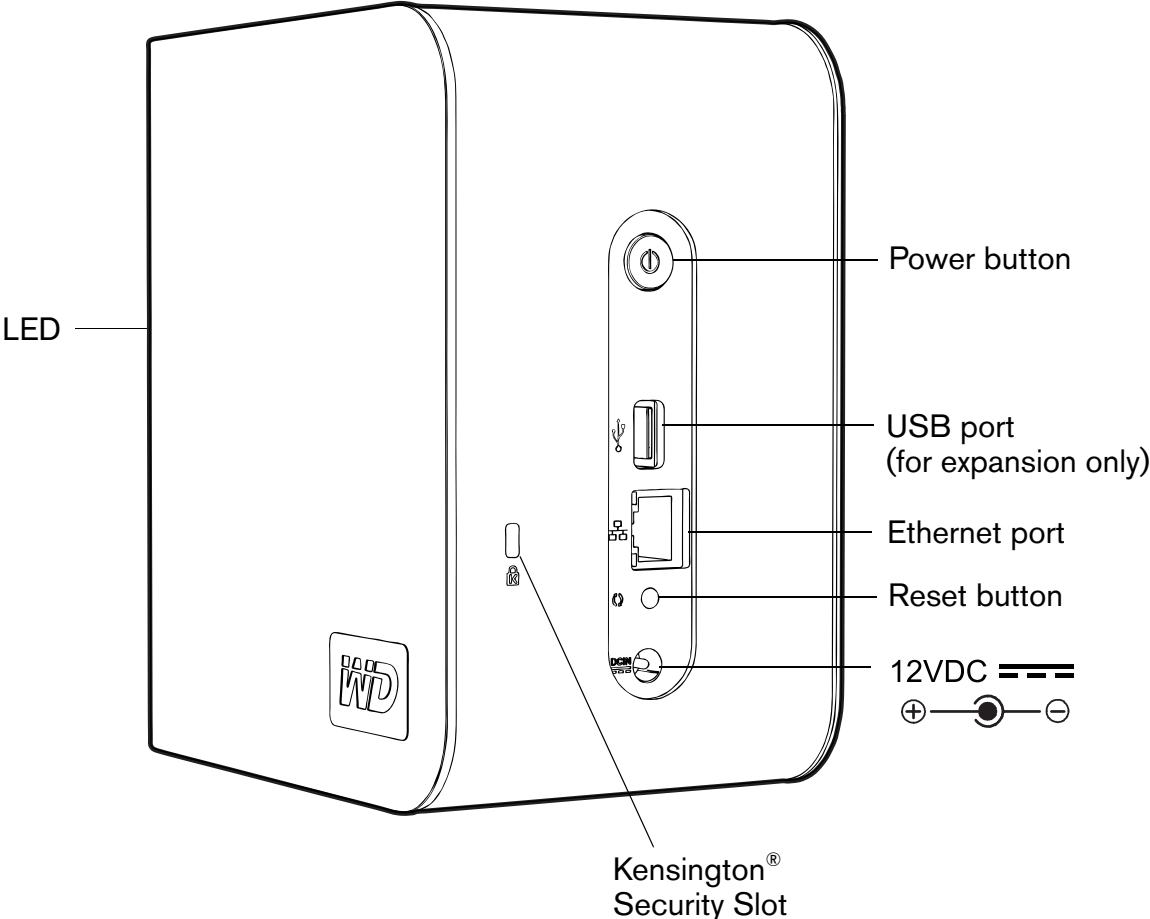

In the following table, write the serial number and model number of your new WD product found on the label on the bottom of the device. Also, write the purchase date and other notes such as your operating system and version. This information is necessary for setup and technical support.

Serial Number:
Model Number:
Purchase Date:
System and Software Notes:

## System View



## Ports

Component	Icon	Description
USB port		Connects to a USB hard drive for additional storage. <i>Do not</i> use the USB port to connect directly to a computer. Note: This port makes it possible to create backups of digital files from a USB hard drive to the device and vice-versa using the Copy Manager feature. See “Copy Manager” on page 123 for detailed instructions.
Ethernet port		Connects the device to a local network.
Reset button		Press to restore the admin user name and password for the device.
Power port		Connects the device to an AC adapter and the power outlet.

## Reset Button

The reset button restores configuration settings such as the network mode/IP address and admin name and password to default factory settings without erasing shared folders and volumes. For more information on how to reset the system, see “Resetting the network storage system” on page 132.

## Power Button



.....

**Important:** The device powers on automatically upon initial connection to power, which may take up to three minutes. During this time, do not press the power button. After the initial setup, you will need to use the power button to turn the unit on and off.

The power button turns the device on or off. To turn on the device, press the power button and hold it down until the bottom LED illuminates, then release. Holding the button down for four seconds powers off the device.

When power is applied to the unit by plugging in the external power supply connected to the DC plug connector, the unit automatically powers up. This ensures the unit will automatically restart after a power failure.

If you power down a My Book World Edition by pressing the power button, and disconnect and then reconnect the power plug, the unit powers up for about 30 seconds and then powers itself down. This ensures that the unit will not turn on accidentally and remain on if there is a power failure. You will need to press the power button to turn the unit on.

## Kensington Security Slot

For drive security, the device is equipped with a security slot, which supports a standard Kensington security cable. For more information on the Kensington security slot and available products, visit [www.kensington.com](http://www.kensington.com).

## LED Indicators (Lights)

The Power/Activity and Capacity Gauge indicators are represented by a single bar of six LEDs (lights) on the front panel of the drive.

### Power/Activity LED Behavior

#### Power On Sequence

Appearance	Drive State
Bottom LED dimmed	Powering up
LEDs light up in sequence from bottom to top	Transitioning to drive ready

#### Normal Operation

Appearance	Drive State
Capacity Gauge, steady illumination (see below)	Power-on state, ready for use
Moving up and down	Drive in use
Slow flashing (every four seconds)	System standby

#### Capacity Gauge

When the device is turned on, the Capacity Gauge indicates space used on the drive by fully illuminating six sections in an upward vertical direction. Each section represents approximately 17 percent of drive capacity. Because this drive is preformatted, the first section is illuminated upon installation.

#### Power Down Sequence

Appearance	Drive State
Dimming up/dimming down in an odd/even alternating pattern	Drive powering down

#### Device Events

Appearance	Drive State
Bottom LED dimmed, top LED flashing	Boot unsuccessful
Fast flashing (every half second)	My Book system event, action required (see "System Events" on page 136)
Continuous "center out" sweep pattern	Unit failure

# 2

## My Book World Edition Basic Setup

### Step 1: Connect My Book World Edition to the Network

Follow the steps below to connect the network storage system to a small home/office network.

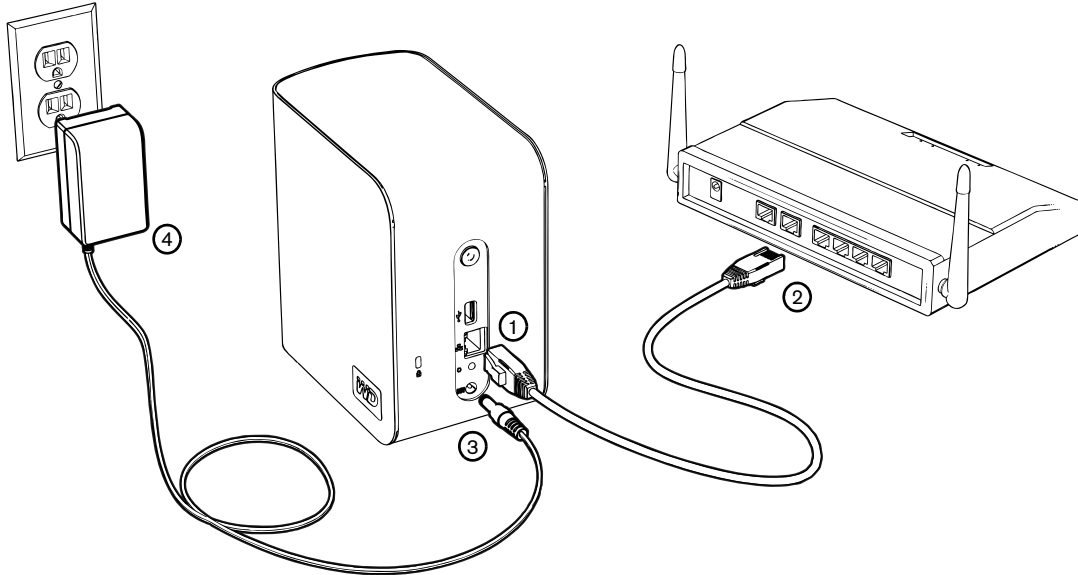

1. Connect one end of the Ethernet cable into the Ethernet port located on the back of the device.
2. Connect the other end of the Ethernet cable directly into a LAN port in a router or network switch.
3. Connect the end of the adapter into the DC power supply socket located on the back of the device.
4. Plug the AC adapter into a power outlet. The unit powers up automatically.



**Important:** Wait for the network storage system to finish powering up (approximately three minutes) before configuring the device. During this time, do not press the power button. The bottom LED on the front of the My Book device fully illuminates.

To power down the device, press and hold down the power button down for at least four seconds.

## Step 2: Access My Book World Edition on the Network

You can easily find your My Book World Edition on the local area network (LAN) using WD Discovery™. Follow the appropriate procedure below:

- Windows XP on page 11
- Windows Vista on page 14
- Macintosh Leopard on page 17
- Macintosh Tiger on page 18



.....  
*Note:* The WD Discovery application on the included CD should be installed on every PC connected to the LAN from which you intend to access your My Book World Edition.

### Windows XP

1. Turn on your computer and wait for the operating system to load.
2. Insert the software-installing CD into the CD or DVD ROM drive.



.....  
*Note:* If AutoPlay is disabled on your computer, you must install the utilities manually. **To enable the AutoPlay** option, click **Start** and click **My Computer**. A new window opens. Locate and right-click the CD/DVD drive. When the menu window opens, click the **AutoPlay** option. The main CD Installer screen displays.

3. Click **Accept** in the Terms of Agreement screen.



4. If you have connected the My Book device properly as shown in the Connect screen, click **Next**.



5. The Application Installer screen opens, displaying a list of options. Click **WD Discovery Tool**. Once the WD Discovery Tool installation is complete, it will automatically launch and the WD Discovery icon will display on your desktop.
6. Click **MyBookWorld** and click **Map Network Drive** in the **Things to Do** list.



A message appears asking whether you want to map the drive automatically. If you want to map the drive manually, skip to step 8.

7. Click **Yes**.



All share folders available on the device will be mapped as network drives automatically. Available drive letters are assigned backwards from Z.

When mapping completes, the share folders appear as network drives in the WD Discovery screen. Click **Back** to return to the main page.



- Manual drive mapping: Click **No**. All share folders on the device are listed on-screen. Select a folder name, then select a drive letter. Click **Yes** to complete drive letter assignment.

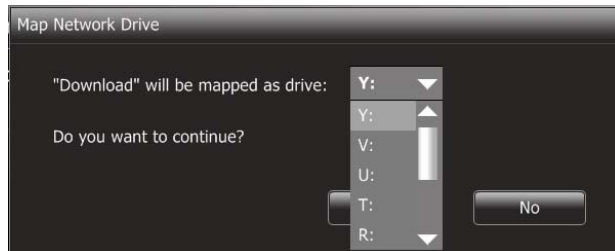

.....  
*Note:* Once a unit is mapped to a network drive, automatically or manually, it keeps the same drive letter.

- Close the WD Discovery Tool.



.....  
*Note:* WD Discovery is only used for initial configuration. You can access the storage drives on My Computer.

- Click **Start** and then **My Computer**. The network drives display. You can now drag and drop files into the network drive folders using **My Computer** or Windows Explorer.

## Windows Vista

1. Turn on your computer and wait for the operating system to load.
2. Insert the software-installing CD into the CD or DVD ROM drive.



.....

*Note:* If AutoPlay is disabled on your computer, you must install the utilities manually. To do this, click **Start** and then **Computer**. A new window opens. Locate and right-click the CD/DVD drive. When the menu window opens, click the **Install or Run Program** option. The main CD Installer screen displays.

3. If you have connected the My Book device properly as shown in the Connect screen, click **Next**.

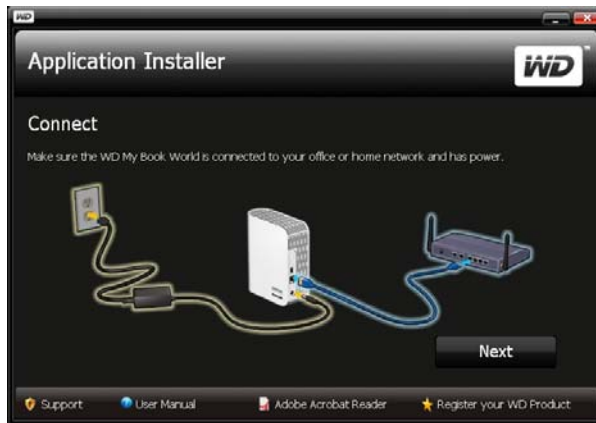

4. The Application Installer screen opens, displaying a list of options. Click **WD Discovery Tool**. Once the WD Discovery Tool installation is complete, it will automatically launch and the WD Discovery icon displays on your desktop.



- Click **MyBookWorld** and then click **Map Network Drive** in the **Things to Do** list.



A message appears asking whether you want to map the drive automatically. If you want to map a drive manually, skip to step 7.

- Click **Yes**.



All share folders available on the device will be mapped as network drives automatically. Available drive letters are assigned backwards from Z.

When mapping completes, the share folders appear as network drives in the WD Discovery screen. Click **Back** to return to the main page.



- Manual drive mapping: Click **No**. All share folders on the device are listed on-screen. Select a folder name and then select a drive letter. Click **Yes** to complete drive letter assignment.

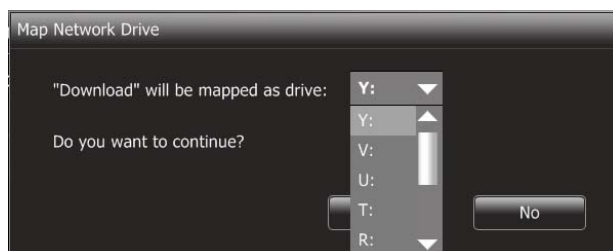



.....  
*Note:* Once a unit is automatically or manually mapped to a network drive, it retains the same drive letter.

8. Close the WD Discovery Tool.



.....  
*Note:* WD Discovery is only used for initial configuration. You can access the storage drives on My Computer.

9. Click **Computer**. The network drives display. You can now drag and drop files into the network drive folders using **Computer** or Windows Explorer.

## Macintosh Leopard

1. Turn on your computer and wait for the operating system to load.
2. Open Finder.
3. In Finder, click **mybookworld** in the **Shared** list (if necessary, click **All** and then double-click **mybookworld**).

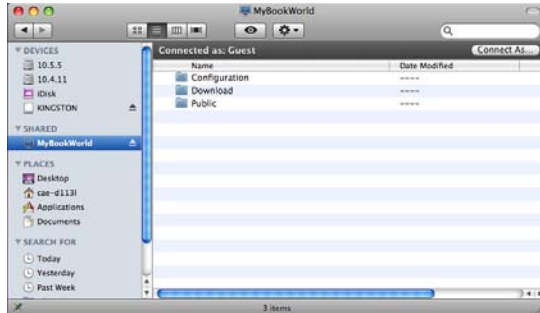

-----  
Note: Configuration is a read-only share containing only a Help file and the login page.

4. Double-click the **Public** share, and then click **OK**. The share may appear as a shared drive icon on the desktop depending on your preferences.

To make the shared drive icon permanent on the desktop, create an alias:

- (a) Click the item you wish to alias and hold down the mouse button.
- (b) While holding down the **Cmd** and **Option** keys simultaneously, drag the item to where you want the alias to appear, and let go of the mouse button. Instead of moving the original item, this will create an alias at the new location.

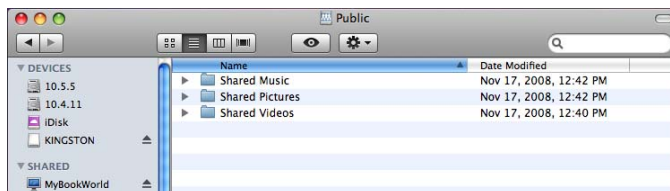

You can now drag and drop files into the network drive folders using Finder.

## Macintosh Tiger

1. Turn on your computer and wait for the operating system to load.
2. Open Finder. Click **Network** and then double-click the Mybookworld icon.



3. Type "admin" in both the **Name** and **Password** fields, and then click **Connect**.

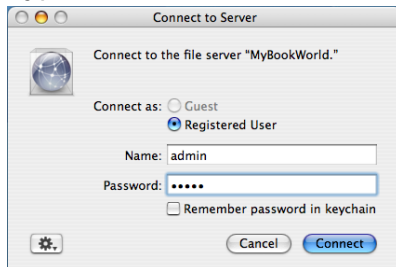

4. Make sure that **shares** is highlighted in the **Select the volumes to mount** list, and then click **OK**.

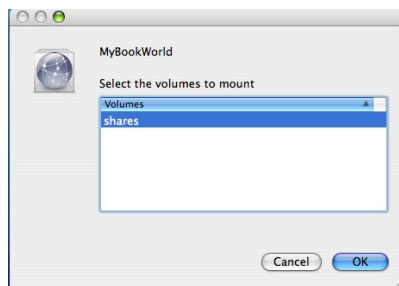

The share may appear as a shared drive icon on the desktop depending on your preferences. To make the shared drive icon permanent on the desktop, create an alias:

- (a) Click the item you wish to alias and hold down the mouse button.
- (b) While holding down the **Cmd** and **Option** keys simultaneously, drag the item to where you want the alias to appear, and let go of the mouse button. Instead of moving the original item, this will create an alias at the new location.

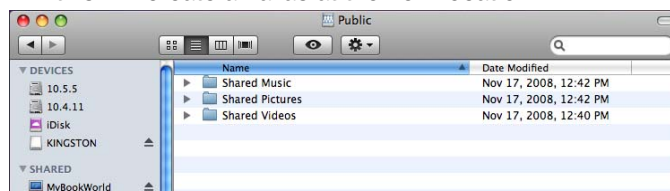

5. In Finder, click **shares** to display the Download and Public folders.



6. Double-click the Public folder. You can now drag and drop files into the shared folders using Finder.



## **Congratulations!**

Your My Book World Edition is now ready for use and is accessible as a drive letter in My Computer (Windows) or a shared drive icon on the desktop (Macintosh). You can now drag and drop files into your My Book device and move files from My Book to any computer in your network that has been set up according to the instructions above.

This user manual contains information and instructions for all other basic and advanced My Book device management functions, including:

- Backing up your computer (see “How to Back Up Computers on the Network” on page 21)
- Accessing My Book from a remote computer (see “MioNet Remote Access” on page 33)
- Playing and streaming media (see “How to Play/Stream Video, Music & Photos” on page 36)
- Using iTunes service (see “Using iTunes with My Book World Edition” on page 44)
- Connecting a USB drive for additional storage and file exchange (see “Connecting a USB Hard Drive” on page 46 and “Copy Manager” on page 123)
- Configuring the My Book device and network settings, set e-mail or window alerts, change the administrator password, perform firmware upgrades, restore system to factory defaults, configure RAID (My Book World Edition II only), manage file share preferences, set the backup destination folder, set disk quotas, set a share folder for users, add, modify, and delete users and groups, and change all user and group permissions (read/write, read only, no access) to shares/folders and USB storage devices (see “Network Storage Manager” on page 53)

## My Book World Edition File Storage

You can access and store content on My Book World Edition via network shares. Shares are folders that can be used to organize and store files on your My Book World Edition network storage system. Shares can be shared with everyone (public) or with selected users on your network (private).

The device comes preconfigured with three preconfigured and populated shares:

- **Public**—created automatically after initial setup
  - Shared Music - folder for storing music files you want to share with other users.
  - Shared Pictures - folder for storing image files you want to share with other users.
  - Shared Videos - for storing video files you want to share with other users.



.....

**Important:** Do not change or delete these default share folders. Disruption of file sharing could result. These are the default folders for the Media Server (Twonky Media) and iTunes Service. For more information on how to use Twonky media, see “How to Play/Stream Video, Music & Photos” on page 36. For more information on how to use the iTunes service, see “Using iTunes with My Book World Edition” on page 44.

- **Download**—for saving files using Downloader (see “Scheduled Downloads” on page 118).
- **Configuration**—this is a read-only share containing only a Help file and the login page. It is not meant for sharing or storing data and should not be modified.

# 3

## How to Back Up Computers on the Network

### WD Anywhere Backup

WD Anywhere Backup automatic backup software allows you to set up continuous backup for up to five computers in your network. Select the files you want to back up, then set it and forget it; every time you save a change it's automatically backed up.

### Installing WD Anywhere Backup



**Important:** You must have your My Book World Edition connected to your local area network and powered on before you install WD Anywhere Backup software. This will ensure that the WD Anywhere Backup recognizes your My Book World Edition and will install as the full software version instead of the 30 Day trial version.

### Windows

1. Turn on your computer and wait for the operating system to load.
2. Insert the software CD into the CD-ROM drive.  
*Note:* If AutoPlay is disabled on your computer, you must install the utilities manually. Click **Start** and then **Computer** (Windows Vista) or **My Computer** (Windows XP). Double-click **Setup.exe** in the root directory of the CD.
3. *Windows Vista:* Click **Run setup.exe** and then click **Allow**.
4. Click **Accept** in the Terms of Agreement screen.
5. If you have connected the device properly as shown in the Connect screen, click **Next**.
6. Click **WD Anywhere Backup**.



*Note:* It may take a minute or two for the next screen to display.

7. Select your preferred language from the list and click **OK**.

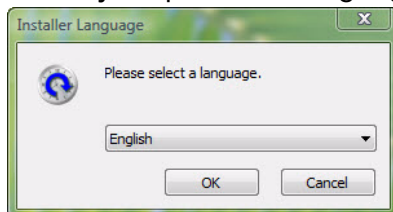

8. Close all other open applications then click **Next** to continue.



9. If you accept the terms of the agreement, click **I Agree** to continue.

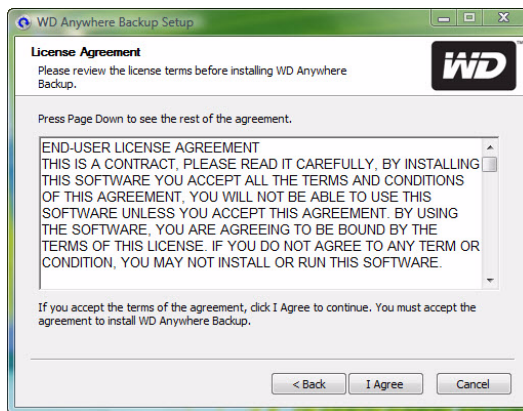

10. After WD Anywhere Backup has finished installing, click **Finish** to begin using WD Anywhere Backup.

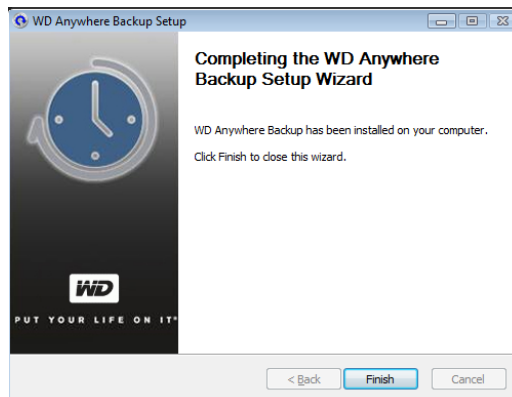

The WD Anywhere Backup Configuration screen displays. Continue with “One-Click Backup” on page 24.



-----  
*Note:* The **WD Anywhere Backup** icon now displays on your desktop, and WD Anywhere Backup is listed in Program Files.

## Macintosh

1. Turn on your computer and wait for the operating system to load.
2. Insert the software CD into the CD-ROM drive.
3. Double-click the My Book World Edition CD icon that mounts to the desktop.
4. Open the WD\_Mac\_Tools folder and double-click WDAnywhereBackup.dmg.

## Configuring WD Anywhere Backup

### One-Click Backup

WD Anywhere Backup allows you to back up all contents of your computer's hard drive with the click of a button. This feature backs up all your data to the network storage system so you can restore all your data in the event that your computer's hard drive crashes.



.....  
*Note:* The backup does not include application files, such as MS Word or Adobe Acrobat, temporary and log files, virtual hard disk files, files in the system folders.

When you first install WD Anywhere Backup, the WD Anywhere Backup Configuration screen displays.



.....  
*Note:* The screen below only appears when you have My Book World Edition attached to your computer's local area network.

1. You have two options:

- (a) To start an automatic and complete backup of your computer's hard drive, click **Back Up All of My Files**. Continue with step 2.



- (b) To customize the backup, click the **Customize My Backup link**. The Welcome screen displays. Continue with step 3 in "How to Create a Backup Plan" on page 27.

2. A message displays a list of files that will not be backed up. For information on backing up those files, see “How to Create a Backup Plan” on page 27. Click **OK**.

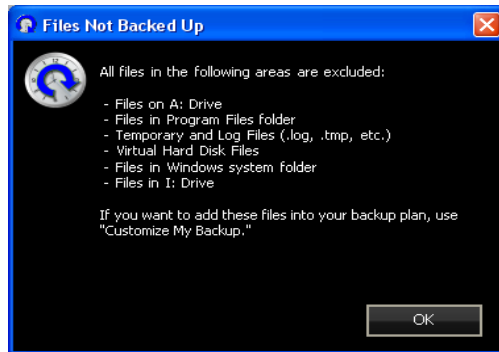

3. A message explains that initial backup will use moderate resources on your computer. To pause the backup, click **Pause until System Idle**. To keep the backup running in the background, click **Continue**.



.....

*Note:* If you do not want these messages to display in the future, click **Do not show Configuration Wizard at startup**.

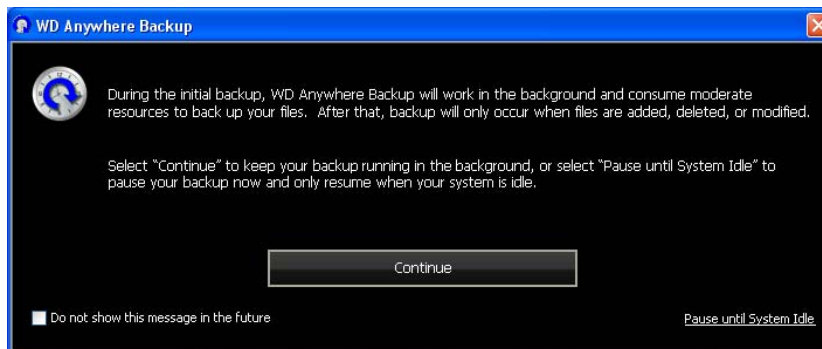

4. A registration screen displays. If desired, enter the registration information. Click **Continue**.

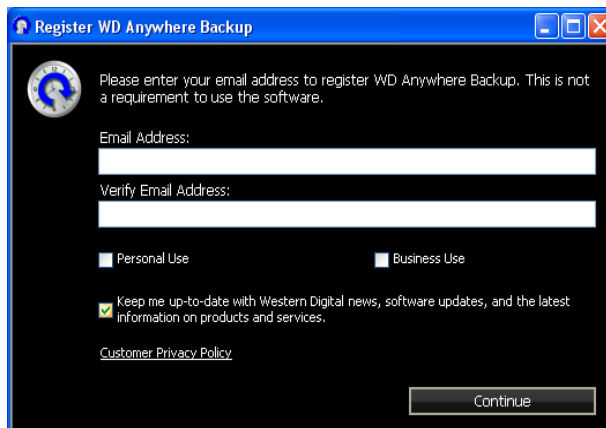

The WD Anywhere Backup screen displays the progress of the backup.

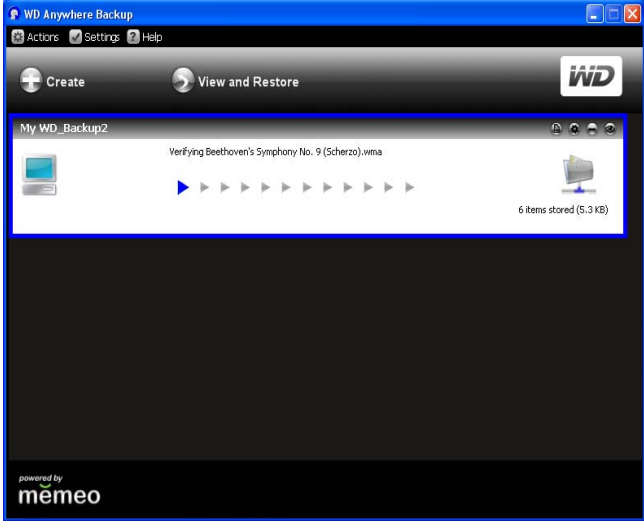

When the backup has finished, a backup complete message displays.

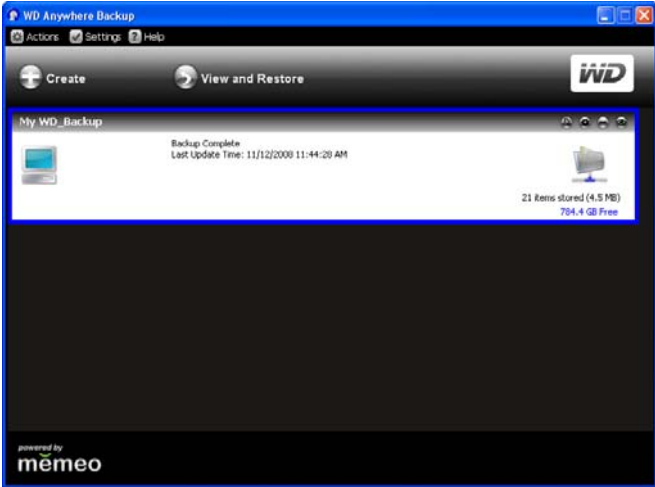

## How to Create a Backup Plan

Creating and customizing a backup plan allows you to automatically safeguard against data loss.

1. If WD Anywhere Backup is not already running, click the WD Anywhere Backup icon on the desktop.
2. Click **Create**.

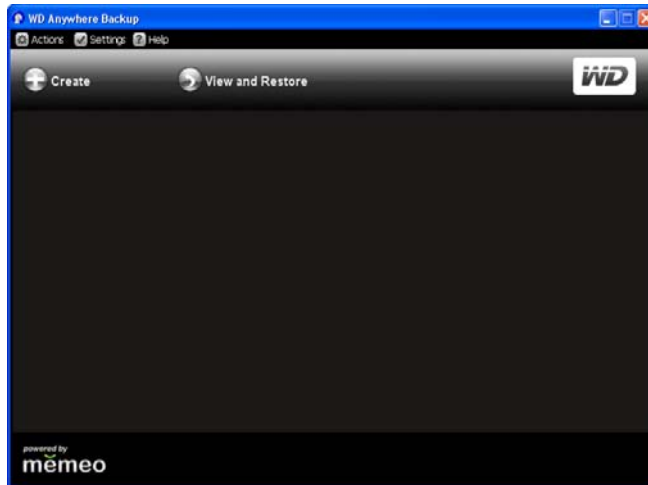

3. The welcome screen displays. Click **Next**.

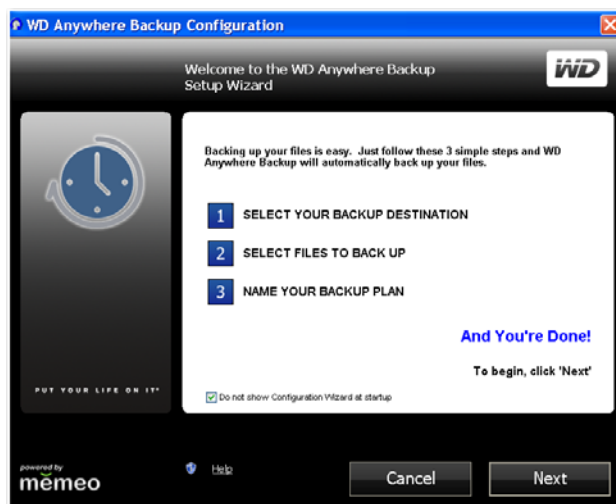

4. Click **Network Places** to locate your My Book World Edition on your local area network. Click **Next**.

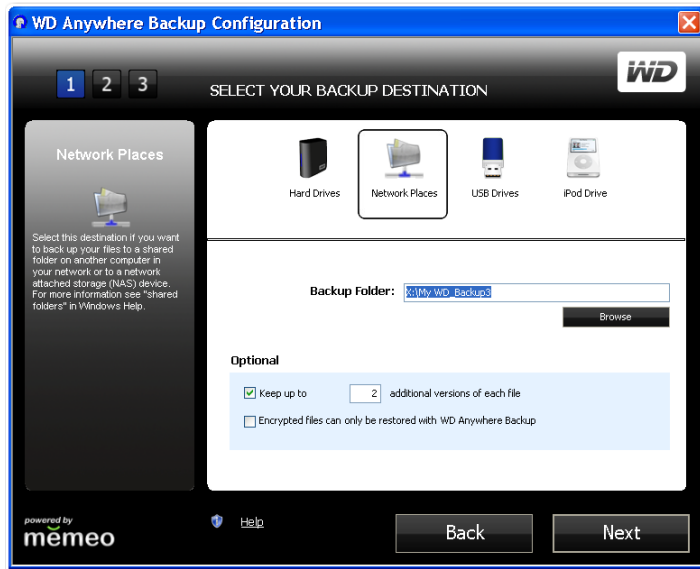

5. Click **All Items from SmartPicks**.

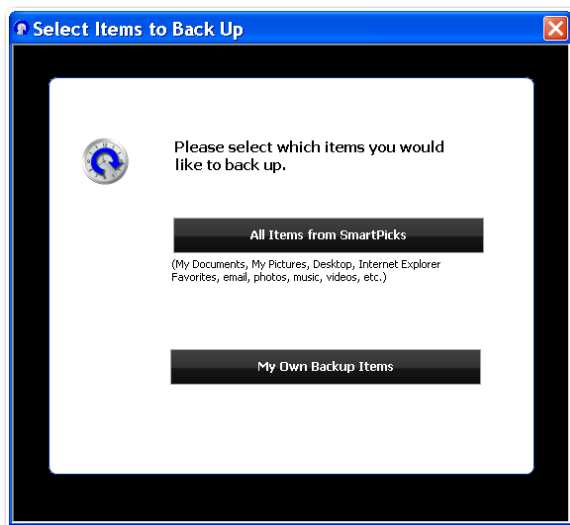

- The SmartPicks screen displays, listing common file types that you can back up. Select each file type you want to back up. When finished, click **Next**.

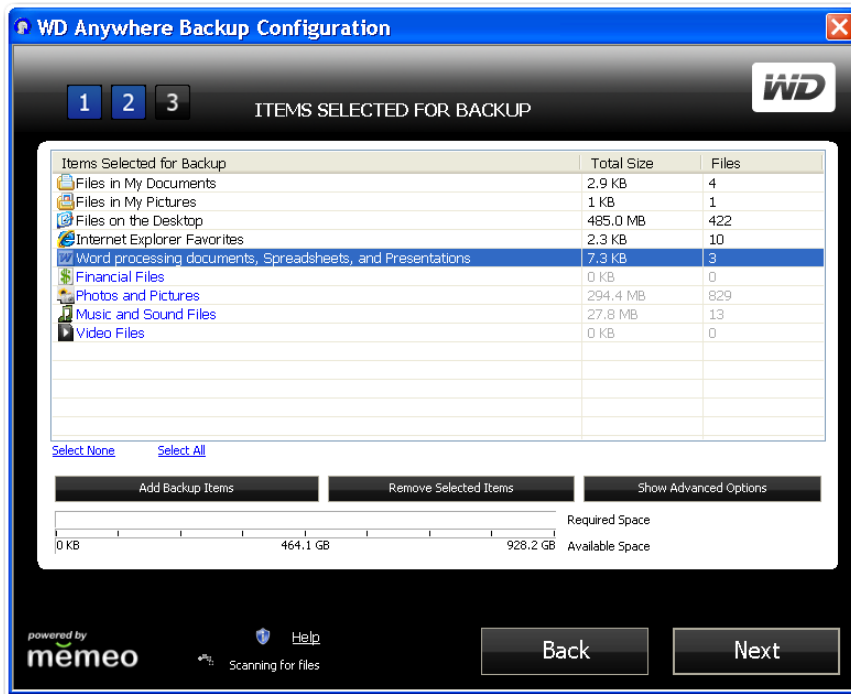

- Name your backup plan and click **Next**. You can create additional backup plans by repeating the steps above.

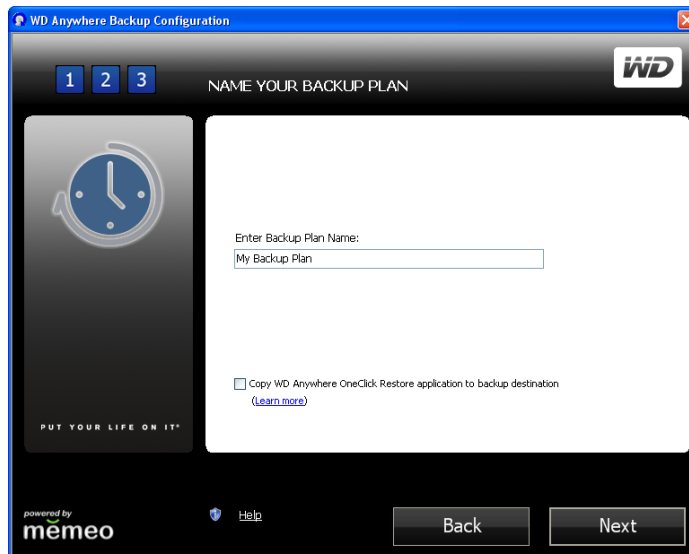

8. A confirmation screen displays. Click **Done**.

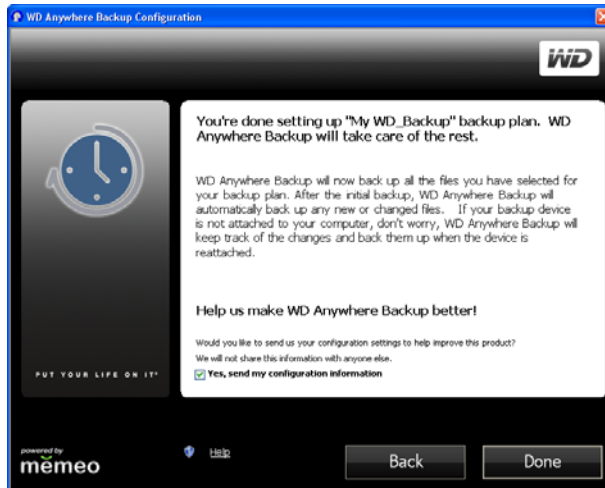

9. A message explains that initial backup will use moderate resources on your computer. To pause the backup, click **Pause until System Idle**. To keep the backup running in the background, click **Continue**.

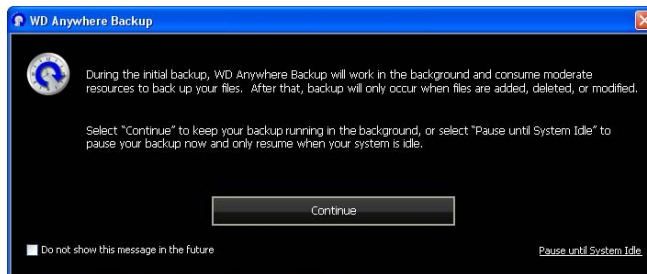

The WD Anywhere Backup screen displays the progress of the backup.

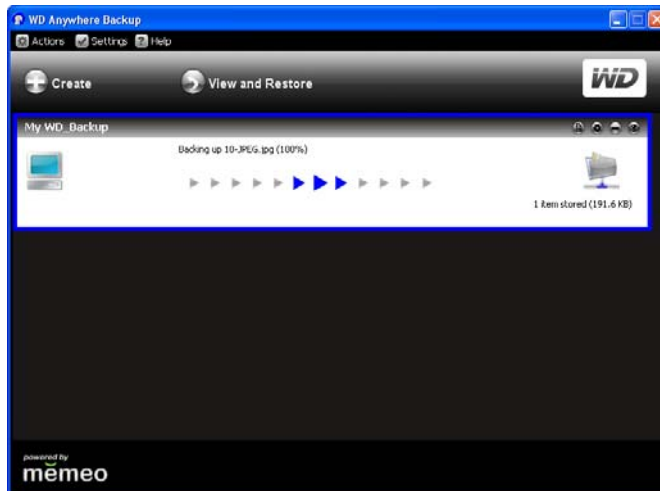

When the backup finishes, the Backup Complete screen displays.

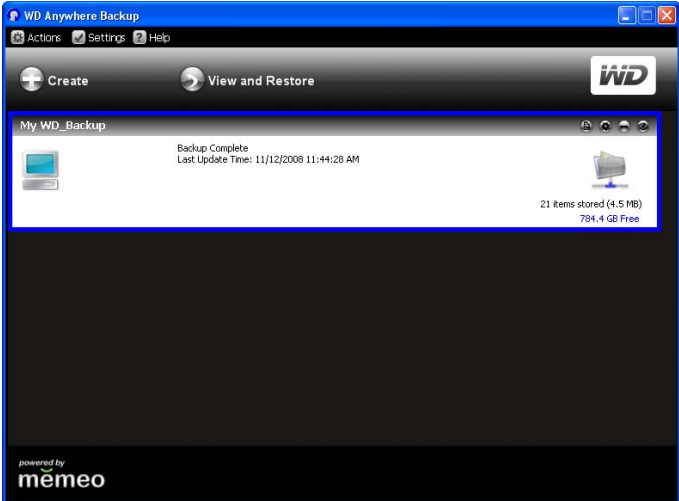

### Editing a Plan

Click the menu icon to add or remove files to and from backup plans, keep multiple revisions of files on hand for recall, and remove entire plans.

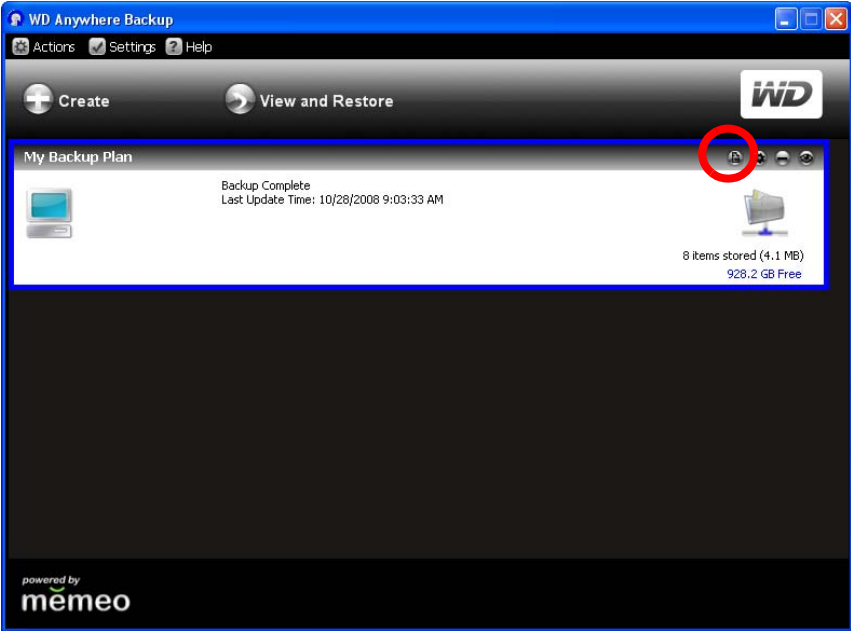

## Restoring a Backup Plan

You can restore a backup plan in the event that you have accidentally deleted a file, want to compare file versions, or have lost all data due to a hard drive crash on your computer.

1. Click **View and Restore**.

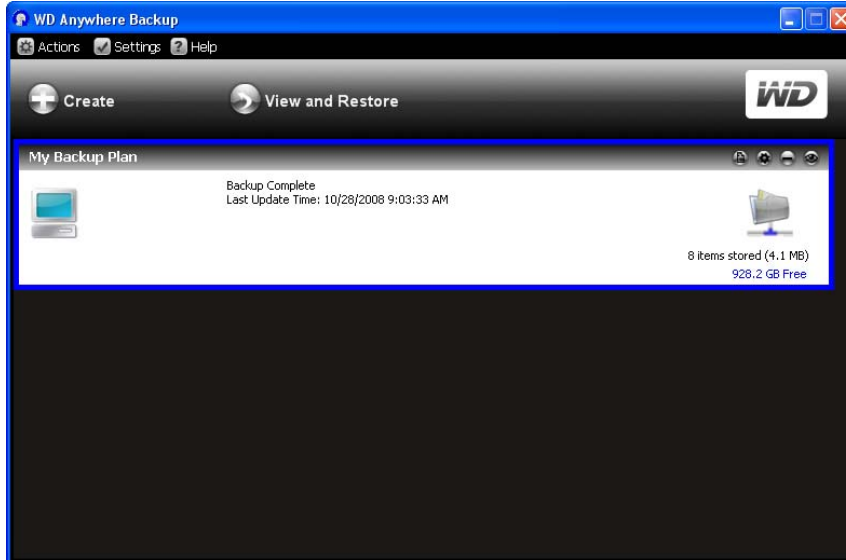

2. Click a backup plan in the **Select a Plan** list, or to search for a backup plan, enter the name in the **Search by File Name** field and click **Search**.
3. Click the box(es) next to the folders or files you want to restore.
4. Select a location to restore your files from the **Restore Files to** list.
5. Click **Restore**.

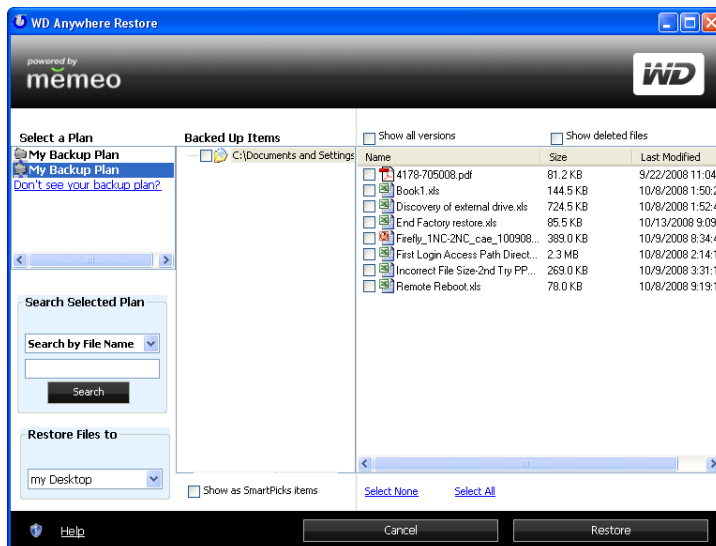

## 4

# MioNet Remote Access

## Overview

Access your photos, music, documents, and videos from anywhere, anytime using MioNet secure remote access services from WD. MioNet makes remote file access and sharing seamless, simple and very secure. Just follow the steps to register your My Book World into your secure MioNet account. Then you can access your content from any web browser in the world with your unique username and password.

MioNet also enables you to share a folder of pictures on your My Book World with friends (no upload required) or a folder of documents with your business colleagues. Invitees can view the content you share with them, but nothing else.

## Remote Access Setup

My Book World Edition comes with MioNet enabled by default. The **Remote Access** menu in Network Storage Manager allows you to further configure the MioNet service on the storage device. See "Remote Access" on page 69 for further details.



.....  
*Note:* A mouse-over of the registration status shows the MioNet account name if the device is registered. To register with MioNet, go to: <http://www.mionet.com/mybook>.

## Windows

1. Turn on your computer and wait for the operating system to load.
2. Insert the software CD into the CD-ROM drive.

*Note:* If AutoPlay is disabled on your computer, you must install the utilities manually. Click **Start** and then **Computer** (Windows Vista) or **My Computer** (Windows XP). Double-click **Setup.exe** in the root directory of the CD.

3. *Windows Vista:* Click **Run setup.exe** and then click **Allow**.
4. Click **Accept** in the Terms of Agreement screen.
5. If you have connected the device properly as shown in the Connect screen, click **Next**.

6. Click **MioNet Services**.



The MioNet registration screen displays.

7. Complete the registration form and click **Submit** to create an account.

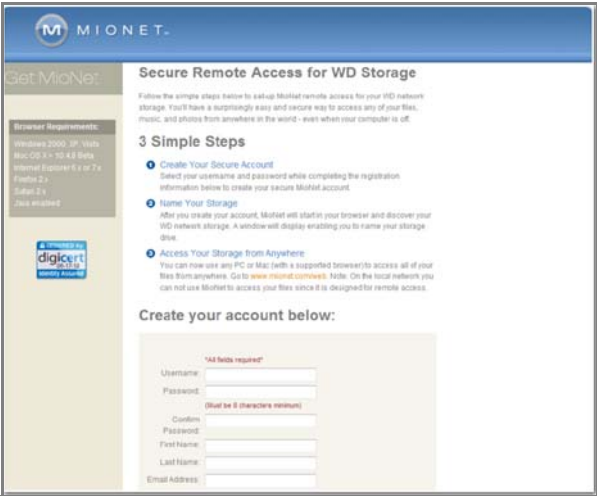

8. A confirmation message displays. Click **OK**.

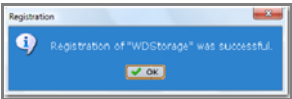

- When MioNet finds the My Book World Edition you are registering, enter a name for the device and click **OK**.



A list of the folders stored on your My Book World Edition displays.



## Using MioNet

Following are guidelines for using MioNet:

- Go to [www.mionet.com/web](http://www.mionet.com/web) from most PCs or Macs in the world to securely access your files.
- Enter the MioNet username and password you created.

Your My Book World folders display in the **My Resources** tab of MioNet, as they did when you set up your account.

- Select a folder to see a list of all the sub-folders and files. You can now use your browser to access your entire collection of music, photos, movies, and documents.
- Double-click any file to open it locally. Depending on the operating system, you may be able to drag and drop files from your My Book World to the remote computer and vice versa.
- See the instructions within MioNet to share a folder of pictures or documents with others.

## 5

# How to Play/Stream Video, Music & Photos

## Media Server Overview

My Book World Edition serves as your home's central media hub. It enables you to stream photos, music, and videos to your home entertainment center and/or other PCs on your home network.

The Twonky Media server application searches for all the media (for example, videos, photos, and music) stored on the My Book World Edition connected to your home network. The server is pre-set, so you can just transfer your multimedia content to the respective shared folders on your My Book World Edition (described on the next page), and you are ready to stream and view content on your home entertainment center, game consoles (for example, XBOX 360, Playstation 3, or DLNA 1.5 Digital Media Adapters), and other PCs on your home network. Visit [www.twonkymedia.com](http://www.twonkymedia.com) for further information on Twonky Media.

## Media Types Supported

Audio	Video	Images
MP3	MPEG1	JPEG
WMA	MPEG2	PNG
WAV	MPEG4	TIF
LPCM	AVI / DivX	BMP
OGG vorbis	WMV	
FLAC	VOB	
M4A	3GP	
M4B	VDR	
MP4	ASF	
3GP	MPE,	
AAC	DVR-MS	
MP2	Xvid	
AC3	M1V	
MPA	M4V	
MP1		
AIF		



*Note:* Some devices may not support playback of all these files. Please refer to your device's user manual to see which formats are supported.

## Media Storage

You can access and store media content on My Book World Edition via network shares. Shares are folders that can be used to organize and store files on your My Book World Edition network storage system. Shares can be shared with everyone (public) or with selected users on your network (private).

The device comes pre-configured with the Public network share, which contains the following folders for media storage:

- Shared Music - folder for storing music files you want to share with other users
- Shared Pictures - folder for storing image files you want to share with other users
- Shared Videos - for storing video files you want to share with other users



**Important:** Do not change or delete these default share folders. Disruption of file sharing could result. These are the default folders for the Media Server (Twonky Media) and iTunes Service. For more information on how to use Twonky media, see “Media Server” on page 105. For more information on how to use the iTunes service, see “iTunes” on page 105.

### How and where to add media content to the shared folders

1. Open the Internet Explorer.

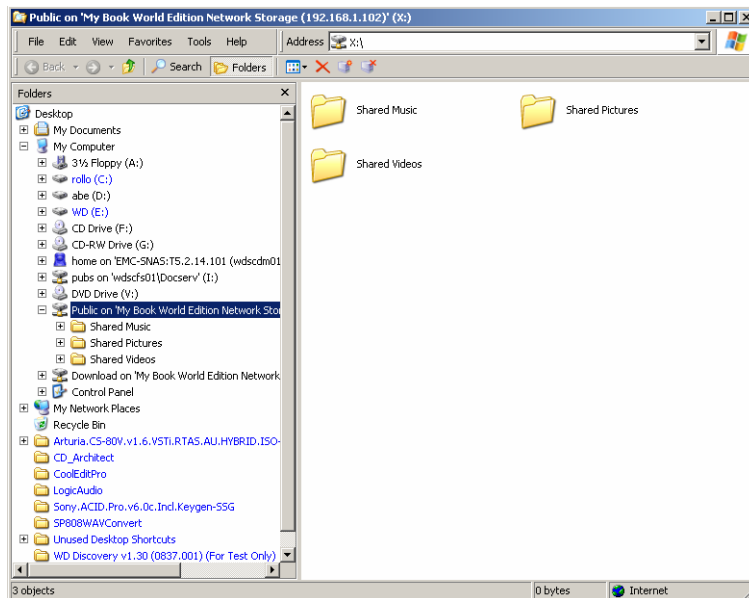

2. Copy your music files to the Shared Music folder and under the Public folder on My Book World.
3. Follow the same process to place your videos and pictures into their respective Shared Pictures and Shared Video folders.



**Important:** Make sure to sort and add your media content to the corresponding shared folders. (e.g., music files must go into the Shared Music folders). If you do not do this, your content will not display correctly through your digital media adapter.

## Media Devices

Now that you have copied your files to their corresponding folders, you can use a variety of media devices to stream media. The following types are discussed in this section:

- Windows Media Player 11 (Windows Vista) on page 38.
- Xbox 360 on page 40.
- Xbox 360 - New User Interface on page 41.
- Playstation 3 on page page 41.
- Digital Picture Frames on page 41.
- Network Music Player on page 42.
- Digital Media Adapters on page page 42.
- DLNA Devices on page page 43.

### Windows Media Player 11 (Windows Vista)

**How to stream media using Windows Media Player 11 Library**

1. Click **Control Panel > Network and Sharing Center**.
2. Click **Customize**.

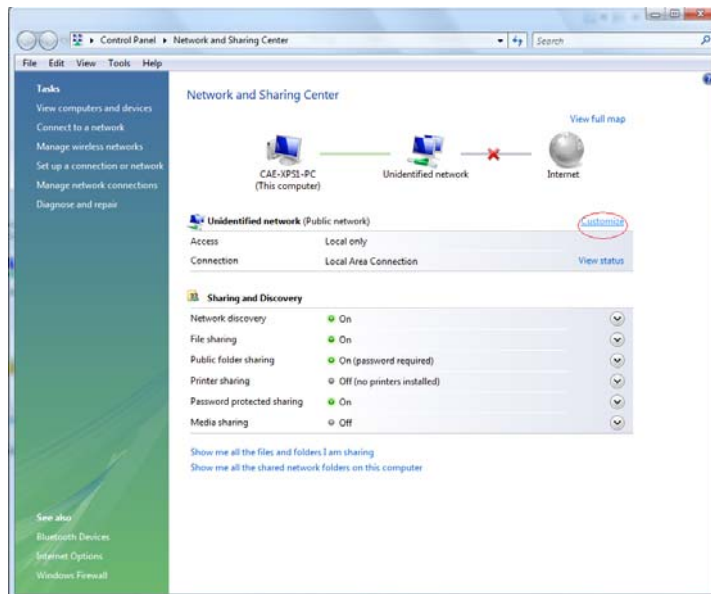

3. Click **Private**, and then click **Next**.

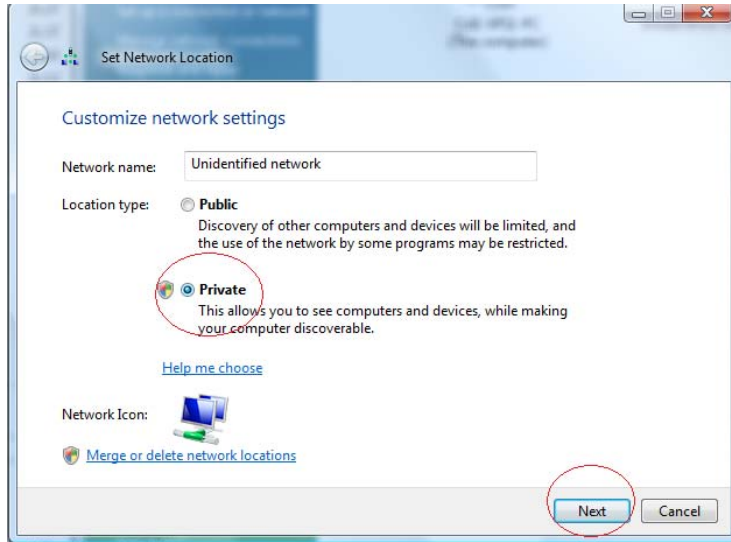

4. Launch Windows Media Player (**Start > All Programs > Windows Media Player**)

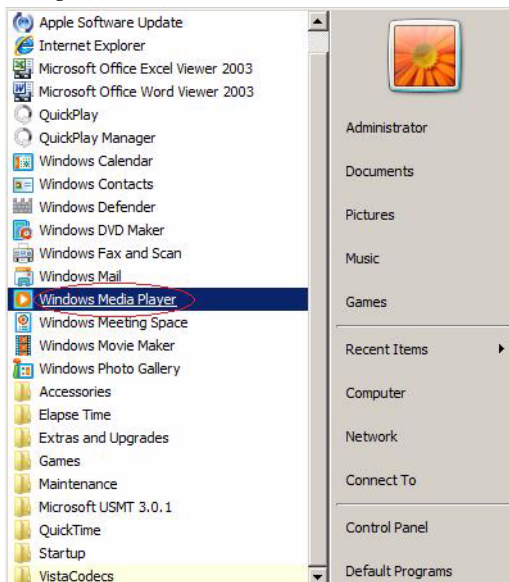

5. Click **Library > Media Sharing**.

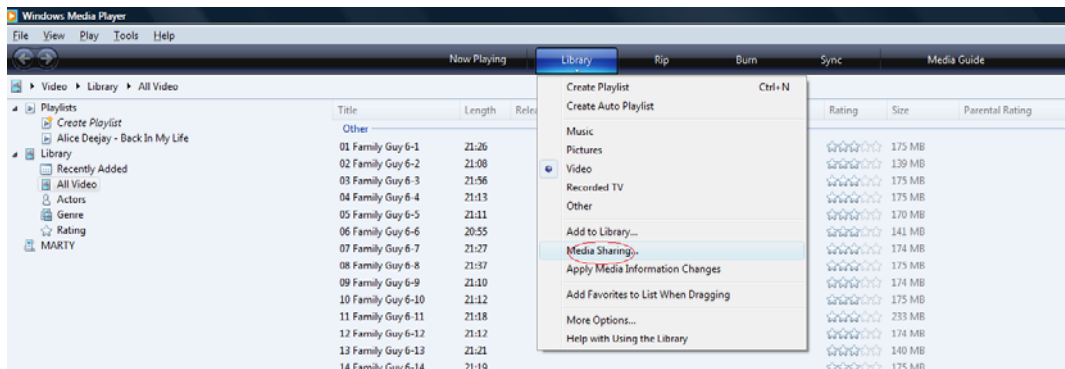

6. Click **Find media that others are sharing**, and then click **OK**.

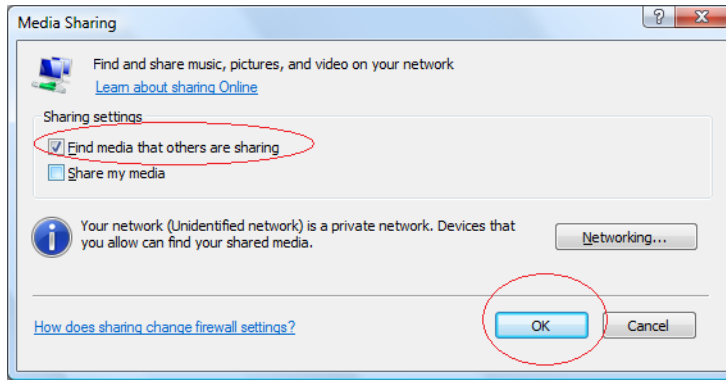

7. Select a media type (Music, Pictures, or Video) and click **PVConnect on MyBookWorld**.

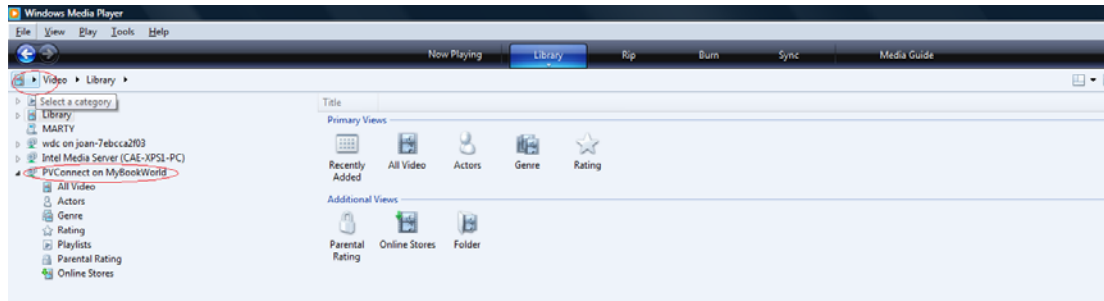

8. Double-click the media file you want to play.

## Xbox 360

1. Ensure that your Xbox 360 and My Book World Edition are powered on and connected to your local area network. The main Xbox screen displays five screens you can scroll through (Marketplace, XBox Live, Media and Network).



.....  
*Note:* If you have any devices with Window Media Center, the XBOX 360 will display a user interface screen asking you to connect to that device. Click **B** to exit.

2. Scroll to the Media Screen and select the Music option (you have three options - Music, Pictures, and Videos). The Source screen displays.
3. Click **MyBookWorld** or the My Book World Edition device name you created previously. The Music player screen displays with the device name at the top of the screen.
4. Click **Songs** to view the songs stored in your Shared Music folder.
5. Use the music player navigation buttons on the screen to play your music files.
6. To view your pictures or play video content that are on your My Book World Edition, go back to step 3 and repeat the steps, selecting the appropriate media (Picture or Video).

## **XBOX 360 - New User Interface**

1. Ensure that your Xbox 360 and MyBookWorld are powered on and connected to your local area network.
2. From the main Xbox user interface, scroll to the My Xbox screen
3. Use the D-Pad and scroll to the right until you see Video, Music and Picture Library options.
4. Select any one of these three options by pressing the **A** button on your controller. The Select Source screen displays.
5. Select the MyBookWorld option based on the device name you created previously and press the **A** button. You will see the media content stored on your MyBookWorld unit.
6. Using the controller, scroll through to view and play your media content.

## **Playstation 3**

1. Ensure that your Playstation 3 and My Book World Edition are powered on and connected to your local area network. You will see the main user interface with a series of options displayed horizontally across your TV screen.
2. Using the directional buttons (left and right) on the PS3 controller, navigate to Music, Photo or Video depending on which type of media you want to play, and press the **X** button.
3. Using the directional buttons (up and down), scroll and select MyBookWorld (or the new device name that you created previously) by pressing the **X** button. You will now see a list of folders (Music, Photo and Video) to the right of the MyBookWorld icon.
4. Make sure that you select the folder that corresponds to option you selected back in Step 2. For example, if you select Photo from the main user interface screen, open the corresponding Photo folder to the right of the MyBookWorld icon, otherwise your content will not display properly.

## **Digital Picture Frames**

The following are general steps for setting up digital photo frames:

1. Ensure that your My Book World Edition is connected to your home's local network and is powered on.
2. Follow the user instructions provided with your wireless digital photo frame to proceed through any initial setup or installation of drivers.
3. Using the navigation feature on your wireless digital photo frame, scan and detect the My Book World Edition on your network.
4. Depending on the brand of photo frame you have, you may need to access Settings/Network Setup page in the user interface to establish connection so that your photo frame can link to your My Book World Edition. Please refer to your DMA's user guide for specific instructions.

5. Once you have a connection between your wireless photo frame and the My Book World Edition, access the Media screen on your photo frame that will provide you the option to view your pictures.



.....  
Please refer to your wireless photo frame user guide for supported picture file formats and instructions on accessing and viewing your pictures.

## Network Music Player

The following are general steps for using a network music player to access My Book World Edition:

1. Connect My Book World Edition to your local area network and power on the device.
2. Connect and configure your network music player on your home's wired or wireless network switch or router.
3. Turn on your network music player.
4. If connected properly, you will find the device name of your My Book World Edition.
5. Navigate through the network music player's user interface to locate and play music stored on your My Book World Edition.



.....  
*Note:* Please refer to your network music player user guide for specific instructions on connecting to a network attached storage system and how to access and play your media content.

## Digital Media Adapters

The following are general steps for using a Digital Media Adapter to access to My Book World Edition:

1. Connect My Book World Edition to your local area network and power on the device.
2. Make sure that your DMA device is connected to your TV and powered on.
3. The main screen of your DMA device displays.
4. Depending on the DMA device, you may need to access the Settings/Network Setup screen in the user interface to establish a connection between your DMA and My Book World Edition. Please refer to your DMA's user guide for specific instructions.
5. Once you have a connection established between your DMA and My Book World Edition, access the Media screen on your DMA to view your pictures or stream music and video content from the My Book World Edition.



.....  
*Note:* Please refer to your DMA's user guide for specific instructions on connecting to the My Book World Edition and how to access and play your media content.

## **DLNA® Devices**

See specific DLNA media device user manuals for instructions on connecting a DLNA device to your local area network so you can access content on My Book World Edition. Go to [www.dlna.org](http://www.dlna.org) for a list of DLNA-certified devices and for further information.

## 6

# Using iTunes with My Book World Edition

## iTunes Media Server Overview

With the iTunes Media Server Service, you or anyone connected to the network storage system can play music files stored on the system using iTunes. This service creates a virtual music library on the device and treats it as an iTunes repository, making it possible for music files to stream from the network storage system to Windows or Mac computers running iTunes.

## Media Types Supported

The iTunes Server Service supports the following file types:

- \*.mp3
- \*.wav
- \*.aac



.....

*Note:* The iTunes server service requires the presence of the '/Public/Shared Music' share folder. Do not rename or delete Shared Music if you want to use the iTunes server. You must recreate or rename the '/Public/Shared Music' folder if it has been deleted or renamed.

## Storing Content

See “Step 2: Access My Book World Edition on the Network” on page 11 for instructions on moving your media files to My Book World Edition’s ‘/Public/Shared Music’ default folder.

## Streaming Audio in iTunes

The iTunes Service is enabled by default in the Network Storage Manager utility. See “To enable or disable the iTunes Server Service:” on page 106 for more information.

1. Launch iTunes on your computer.
2. Click **MyBookWorld** under the Shared section of the left pane. If you have copied music to the /Public/Shared Music folder and it is in a format supported by iTunes, it should be listed in the right pane.
3. Double-click an audio file to play.

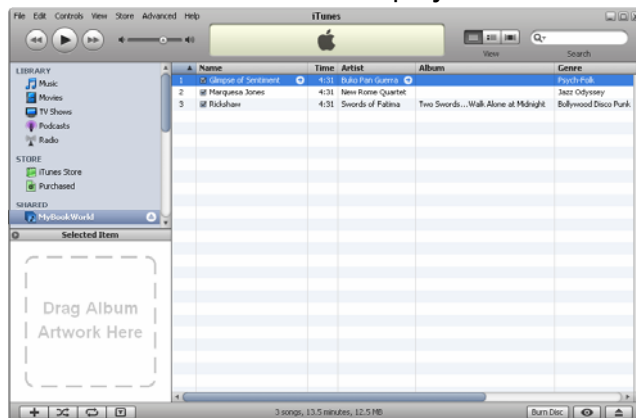

The audio file is streamed in iTunes and audio files from the network storage system are displayed under the **Shared** list.



*Note:* For optimal performance, streaming music or video should be performed on the Local Area Network and not remotely over the Wide Area Network.

# 7

## Connecting a USB Hard Drive

Connect a USB hard drive to the USB port on the rear of your My Book World Edition for additional storage. The USB drive will appear as a Folder Share in Network Storage Manager. See “Folder Shares” on page 66 (Basic Mode) or “Folder Shares” on page 96 (Advanced Mode) for details.



.....  
**Important:** USB hard drives that are formatted with FAT32 are limited to only 4 GB that can be copied for each file. If you try to transfer files that are larger, you may encounter a Copy Termination error.



.....  
*Note:* The network storage system supports external USB storage; USB optical drives (CD/DVD combo or a DVD dual/multi drive) are not supported.

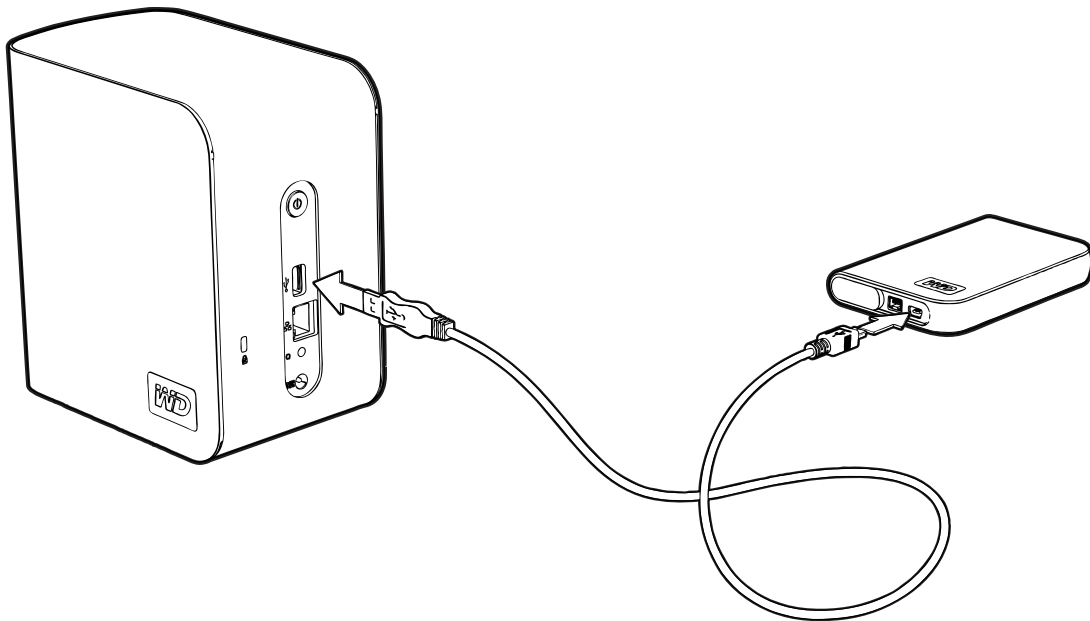

### Copy Manager

The network storage system’s Copy Manager feature allows you to back up data from the USB hard drive to My Book World Edition or back up data from the My Book World Edition to the USB hard drive. See “Copy Manager” on page 123 for instructions.



.....  
**Important:** When backing up data, always connect the USB hard drive directly to a USB port on the network storage system. **Do not use a USB hub.** Ensure that the destination drive has enough free space to store the amount of data being transferred.

8

## Using WD Discovery

WD Discovery is an exclusive web-based utility that aids in the installation of the My Book World Edition network drive. The easy-to-use software enables you to quickly locate and set up the My Book World Edition on your home network from any Windows computer. With WD Discovery, you can easily map network drives, browse its shared folders, and create a desktop shortcut for quick access to your My Book World Edition.

WD Discovery provides the following options:



If you want to access the advanced options in the Network Storage Manager interface, you must configure your My Book device. See “Configuring My Book World Edition” on page 53.



Automatically map a network drive so you can easily share and store data on your My Book World Edition. See “Mapping a Network Drive” on page 47.

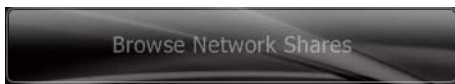

Easily browse network shares without having to manually enter drive paths. See “Browse Network Shares (Windows only)” on page 50.



Create a desktop shortcut that points to a networked My Book World Edition. See “Desktop Shortcut Creation (Windows only)” on page 52.

### Mapping a Network Drive

To access and store data on My Book World Edition after setting up the device, you must first map a network drive to one or more of the default shares. You must install the WD Discovery application on each Windows XP or Vista computer in your network to automatically map a network drive, browse network shares, or create a desktop shortcut.

#### Windows XP



.....

*Note:* Follow the steps below only if you have not installed WD discovery as instructed in “Windows XP” on page 11.

1. Turn on your computer and wait for the operating system to load.
2. If WD Discovery is not running, click **Start > Programs > WD Discovery** or double-click the WD Discovery icon on your desktop.

3. Click the device you want to map in the Network Drives Found list and click **Map Network Drive** in the Things to Do list.



A message appears asking whether you want to map the drive automatically. If you want to map the drive manually, skip to step 5.

4. Click **Yes**. If you want to map the drive manually, skip to step 5.



All share folders available on the device will be mapped as network drives automatically. Available drive letters are assigned backwards from Z.

When mapping completes, the share folders appear as network drives in the WD Discovery screen. Click **Back** to return to the main page.



5. Manual drive mapping: Click **No**. All share folders on the device are listed on-screen. Select a folder name, then select a drive letter. Click **Yes** to complete drive letter assignment.

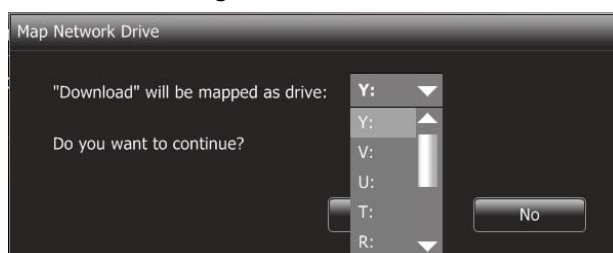

- Click **My Computer**. The network drives display. You can now drag and drop files into the network drive folders using My Computer or Windows Explorer.

## Windows Vista



.....  
*Note:* Follow the steps below only if you have not installed WD discovery as instructed in "Windows Vista" on page 14.

- Turn on your computer and wait for the operating system to load.
- Select the device you want to configure and click **Map Network Drive** in the Things To Do list.



A message appears asking whether you want to map the drive automatically. If you want to map a drive manually, skip to step 4.

- Click **Yes**. Skip to step 4 if you want to map the drive manually.



All share folders available on the device will be mapped as network drives automatically. Available drive letters are assigned backwards from Z.

When mapping completes, the share folders appear as network drives in the WD Discovery screen. Click **Back** to return to the main page.



- Manual drive mapping: Click **No**. All share folders on the device are listed on-screen. Select a folder name, then select a drive letter. Click **Yes** to complete drive letter assignment.

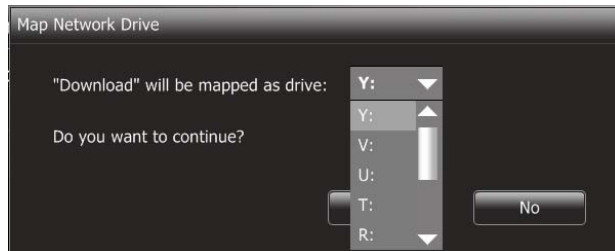

- Click **Computer**. The network drives display. You can now drag and drop files into the network drive folders using Computer or Windows Explorer.



*Note:* Once the WD Discovery Tool installation is complete, it will automatically launch and the WD Discovery icon displays on your desktop.

## Mac OS X

See drive mapping instructions under Basic Setup on page 47.

## Browse Network Shares (Windows only)

To access data on a share using **WD Discovery**:

Use WD Discovery to easily browse network shares without having to manually enter drive paths.

- Ensure that the device is powered on and connected to the network.
- Click **Start > Programs > WD Discovery** or double-click the WD Discovery icon on your desktop.
- Click **MyBookWorld** in the Network Drives Found list and click **Browse Network Shares** in the Things To Do list.



4. After successful login, the share folders on the device are listed. Click a network share path to view and access share files in Windows Explorer.



5. Copy your music files into the Shared Music folder, your video files into the Shared Videos folder, and your photos and pictures into the Shared Pictures folder.

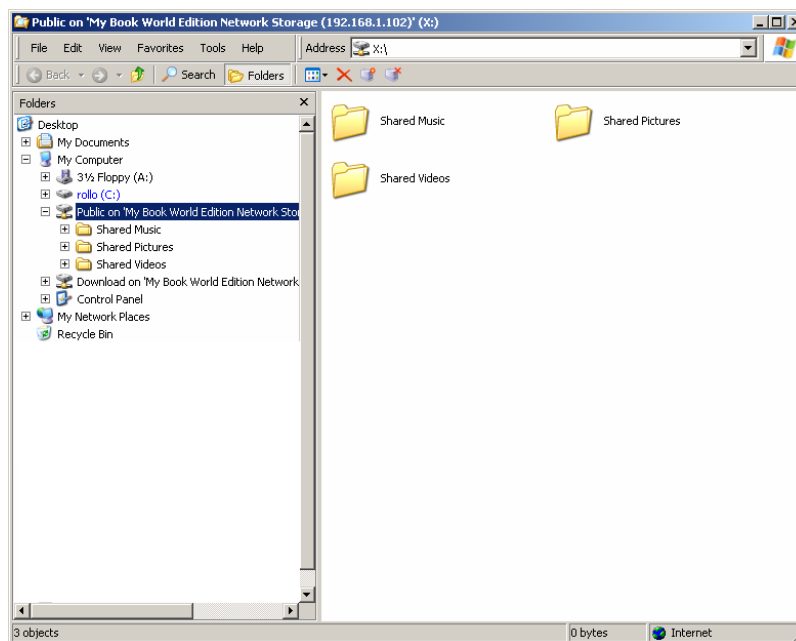

## Desktop Shortcut Creation (Windows only)

WD Discovery can create a desktop shortcut that points to a networked My Book World Edition. Follow these steps to create a desktop shortcut:

1. Ensure that the device is powered on and connected to the network.
2. Click **Start > Programs > WD Discovery** or double-click the WD Discovery icon on your desktop.
3. Click **MyBookWorld** in the Network Drives Found list, and then click **Create Desktop Shortcut** in the Things To Do list.



4. A dialog appears informing you that the desktop shortcut has been created successfully. Click **OK**.

9

# Network Storage Manager

Network Storage Manager is a powerful and convenient web-based management and configuration solution for My Book World Edition.



.....  
*Note:* Accessing and setting up the Network Storage Manager is not required to begin using your My Book World Edition right away.

## Configuring My Book World Edition

You must first configure your My Book World Edition before using the Network Storage Manager user interface. Follow the instructions below for Windows or Mac.

### Windows XP/Vista



.....  
*Note:* Follow the steps below only if you have not installed WD Discovery Tool as instructed on page 11. Otherwise, launch WD Discovery Tool using the desktop icon and continue with step 7.

1. Turn on your computer and wait for the operating system to load.
2. Insert the software CD into the CD-ROM drive.



.....  
*Note:* If AutoPlay is disabled on your computer, you must install the utilities manually. Click **Start** and then **Computer** (Windows Vista) or **My Computer** (Windows XP). Double-click **Setup.exe** in the root directory of the CD.

3. *Windows Vista:* Click **Run setup.exe**, and then click **Allow**.
4. Click **Accept** in the Terms of Agreement screen.
5. If you have connected the device properly as shown in the Connect screen, click **Next**.
6. The Application Installer screen opens, displaying a list of options. Click **WD Discovery Tool**.
7. The WD Discovery screen displays. Click **MyBookWorld** in the Network Drives Found list and point to and click **Configure**.



8. The login page appears. Continue device setup by following the instructions for “Setting up the Device” on page 54.

## Mac OS X

1. Turn on your computer and wait for the operating system to load.
2. Open the Safari web browser.
3. Click the Bookmarks link  in the upper left corner of the screen.
4. Click **Bonjour**, then double-click **MyBookWorld**.

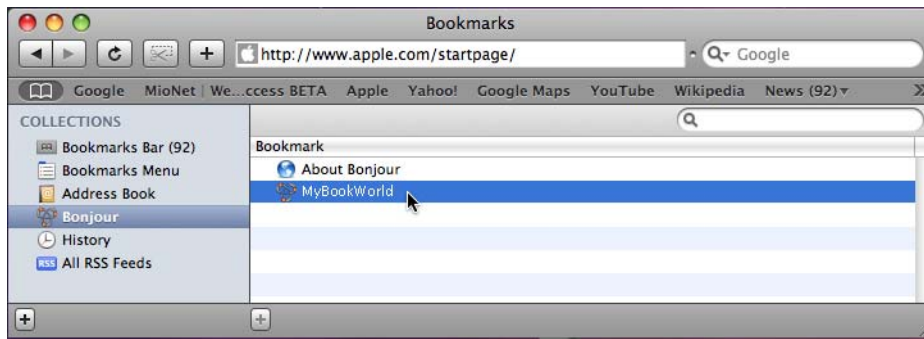

5. The login page appears. Continue device setup by following the instructions for “Setting up the Device” on page 54.

## Setting up the Device

Follow the steps below to continue setting up the device for all operating systems.

1. Enter “admin” in both the **Administrator Name** and **Password** fields.
2. Select a language from the **Language** list and click **Login**.

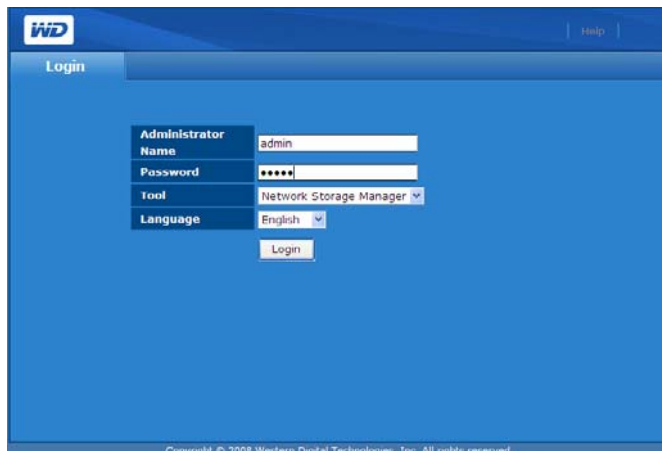

3. Click **Next**.

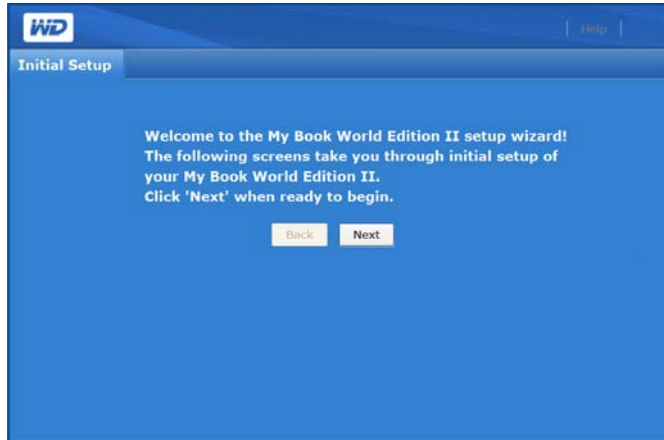

4. Read the license agreement, and then click **I Agree**.

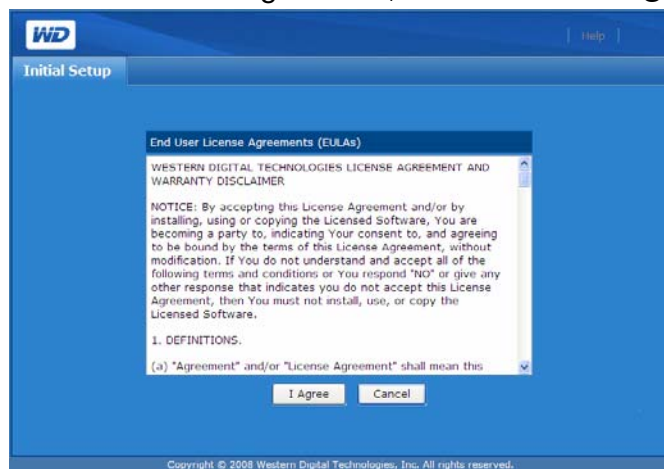

5. In the Initial Setup screen, do the following:

- (a) Enter a name in the **Device Name** field (up to 15 characters, including alphanumeric and dash '-').



.....

*Note:* The device name is used to identify the storage device connected to the network and appears in My Network Places. To connect more than one storage device to the same network, you must specify a unique device name for each storage device.



.....

**Caution:** Renaming My Book World Edition forces all the network computers to remap their shared network resources. Change the device name only when necessary.

- (b) Enter a brief description of the device in the **Device Description** field. The maximum length of the description is 42 alphanumeric characters.
- (c) Select a time zone from the **Time Zone** list.
- (d) If necessary, adjust the date and time manually using the **Date & Time** lists.

Click **Next**.

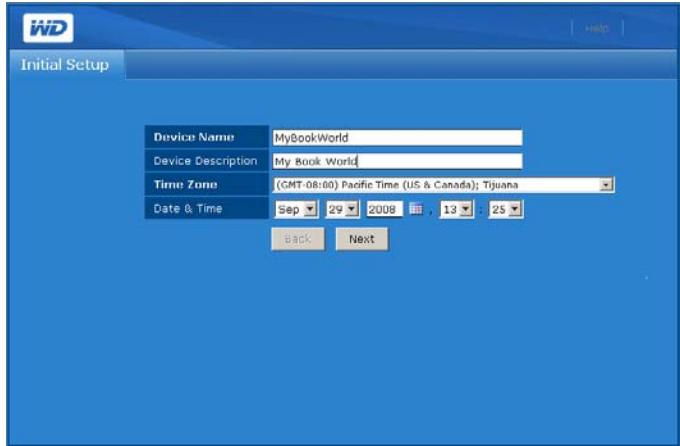

- 6. Enter a new admin password in the **New Admin Password** field. Retype the new password in the **Confirm Password** field. Click **Next**.

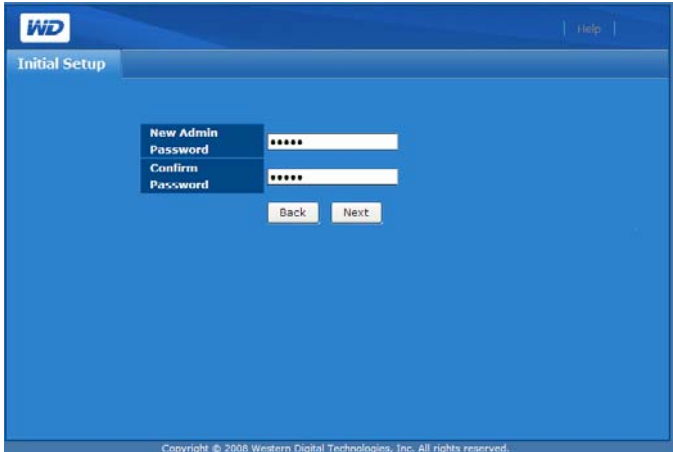

-----

*Note:* If you forget your admin password, you must reset the device to its default configuration using the reset button. See “Reset Button” on page 7 for instructions.

7. Accept the default DHCP (Dynamic Host Configuration Protocol) client settings. If you are not using DHCP, click **Static** and manually assign the IP address. Click **Next**.

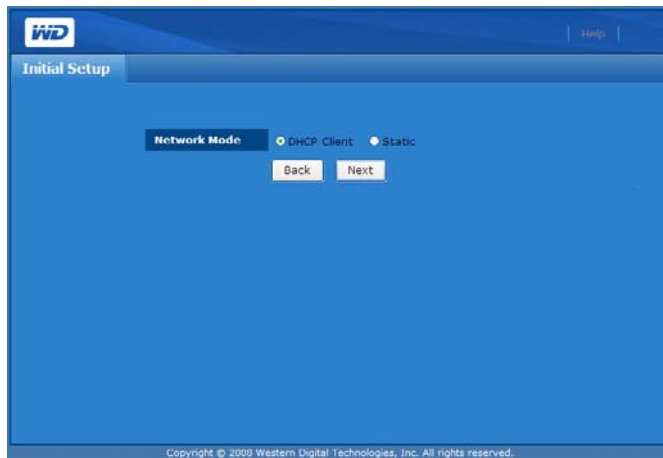

8. The Summary screen displays. Click **Finish**.

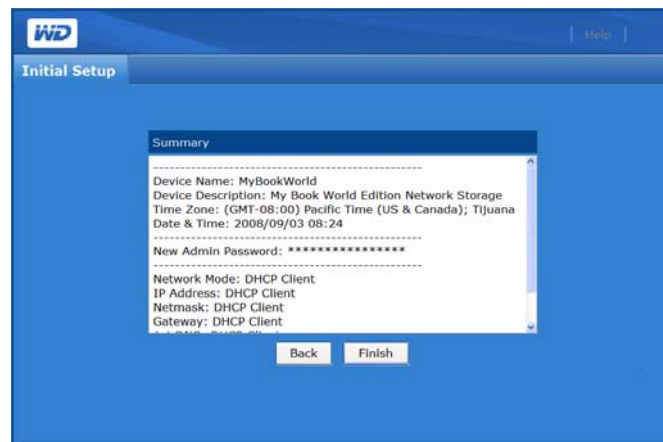

-----

*Note:* If you are using Windows XP or Vista, you may notice a warning notice bar display during the final initialization of your My Book World Edition. The bar warns that the Internet Explorer has blocked an Active X controller message. This warning disappears on its own, or you can click the **X** button to the right of the bar. This warning does not affect setting up your drive.

## Accessing Network Storage Manager

You can manage and configure your My Book World Edition by entering the web-based user interface.



.....  
*Note:* Accessing and setting up the Network Storage Manager is not required to begin using your My Book World Edition.



.....  
**Important:** You must configure My Book World Edition before using Network Storage Manager. Follow the instructions under “Configuring My Book World Edition” on page 53.

### Windows

1. Ensure that the device is powered on and connected to the network.
2. If WD Discovery is not running, click **Start > All Programs > WD Discovery**.
3. Click **MyBookWorld** in the Network Drives Found list and point to and click **Configure** in the Things To Do list.
4. The login page appears. Type in the administrator name and password (the default password is “admin” unless it has already been changed by the administrator). In the **Tool** list, click **Network Storage Manager**. In the **Language** list, click the language for your region. Click **Login**.

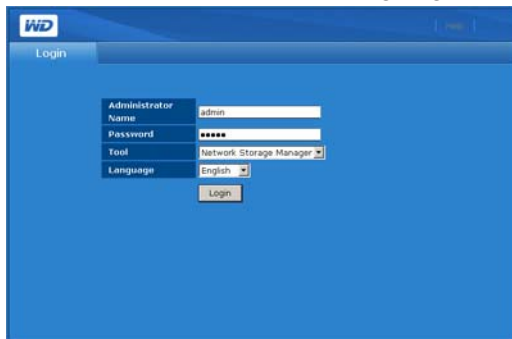

### Mac

1. Turn on your computer and wait for the operating system to load.
2. Open the Safari web browser.
3. Click the Bookmarks link  in the upper left corner of the screen.
4. Click **Bonjour**, then double-click **MyBookWorld**.
5. The login page appears. Type in the administrator name and password. In the **Tool** list, click **Network Storage Manager**. In the **Language** list, click the language for your region. Click **Login**.

## Network Storage Manager Features

The web-based management utility includes the following features:

- **LAN access**—the device supports local area network access of the web-based user interface, enabling management from anywhere in the network.
- **Secured access**—the device can be accessed and configured by the web-based, password protected user interface over SSL (Secure Socket Layer).
- **E-mail notification**—in the event of warnings or errors related to temperatures, hard drive, network, or USB connection, administrators are automatically alerted by e-mail.
- **Multiple management levels**—users can be assigned different rights. The device supports two levels: full access and read only.
- **Update via web**—firmware updates can be downloaded and installed on the device from a computer on the LAN.
- **Disk management**—the web-based user interface allows administrators to monitor internal hard drives and USB hard drives connected to the device.
- **SMART support**—includes SMART (Smart Monitoring Analysis and Reporting Technology) feature for detecting and reporting the status of the SATA hard drives.
- **USB storage support**—allows reliable data backup from a USB storage device to the device.
- **Support for file sharing**—allows file sharing over the network.
- **RAID support (My Book World Edition II)**—allows RAID configuring of the hard drives.
- **Support for Windows and Mac systems**—allows users on different platforms to share files using CIFS (Common Internet File System), NFS (Network File System), FTP (File Transfer Protocol), or AFP (Apple File Protocol) protocols.
- **iTunes streaming support**—allows users connected to the device to stream audio files to iTunes on their computers.
- **Twonky Media server**—provides fast, convenient navigation and searching of all your media files.
- **Remote shutdown or reboot**—allows administrators to power off or reboot the device from any computer on the LAN.
- **System log**—an efficient instrument in analysing and solving technical issues.

### Updating the Firmware

To keep your system up to date, go to **Network Storage Manager > Advanced Mode > System > Update** to upgrade the firmware. For more information, see “Update (Firmware)” on page 77.

## User Interface Overview

The web-based user interface is designed to logically access and manage the features of the device. Upon logging in, the web user interface defaults to basic mode. Basic mode provides access to the most common device configuration options.



The advanced mode page includes six tabs and each tab is subdivided into several menu buttons providing advanced task management functions. The toolbar located on the upper right allows you to switch from the advanced mode and basic mode any time.

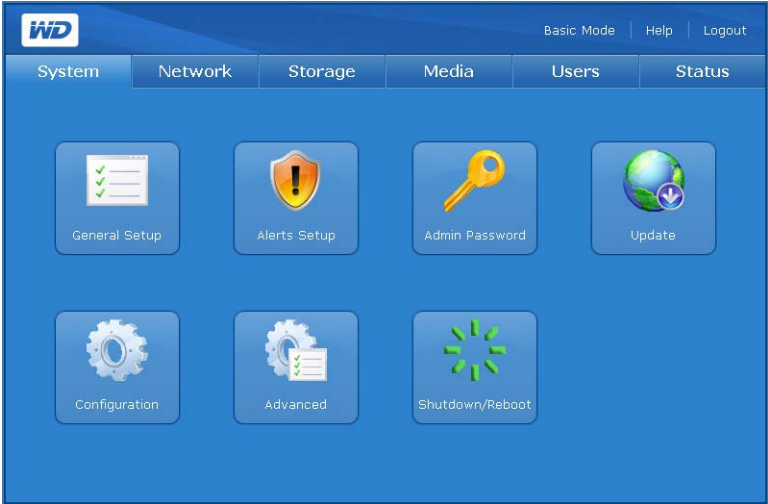

## Toolbar

The toolbar located on the upper right of the Network Storage Manager user interface includes the following commands.

Function	Description
Advanced	Allows you to switch the user interface from basic to advanced mode.
Basic	Allows you to switch the user interface from advanced to basic mode.
Help	Displays online help.
Logout	Closes the browser session and exits the utility.

## Basic Mode

The basic mode provides access to the most common configuration options.

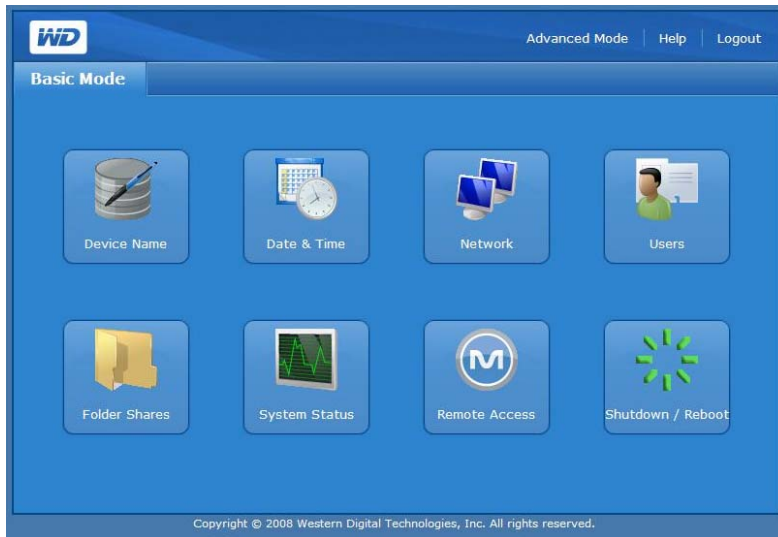

Click any of the menu buttons to display more configuration options. The table below describes the menu options available in basic mode.

Category	Description
Device Name	Enter a device name and description. For more details, see "Device Name" on page 63.
Date & Time	Set the system date and time manually or set the NTP server to synchronize the device. For more details, see "Date & Time" on page 63.
Network	Configure the network connection. For more details, see "Network" on page 64.
Users	Create and delete user accounts and change the user password. For more details, see "Users" on page 65.
Folder Shares	Access configuration details relating to how shares are made available through this storage device. This menu also displays a list of mounted volumes and their available shares. When a USB hard drive is connected to the device, the USB hard drive displays as USB share. For more details, see "Folder Shares" on page 66.
System Status	Displays general information about the storage device, such as device name, firmware version, current date/time, system uptime, IP address, volume usage, and volume RAID type. For more details, see "System Status" on page 68.
Remote Access	Enables or disables the MioNet software. Computers running MioNet can remotely access and share files on the storage device over the internet. <i>Note:</i> Available only on computers running Windows. For more details, see "Remote Access" on page 69.
Shutdown/ Reboot	Performs device shutdown or reboot from any computer on the local area network (LAN). For more details, see "Shutdown/Reboot" on page 69.

## Device Name

Use this option to enter or change a device name and/or a description of the device. The device name is the name by which your My Book World Edition is identified on the LAN.

1. Click **Device Name** in basic mode home screen.
2. Enter or change the text in the **Device Name** and/or **Device Description** fields.
3. Click **Submit**.

## Date & Time

The date and time is synchronized automatically to the NTP (network time protocol) server by default. You have the option to set the date and time manually or allow the NTP to access the internet to automatically set the time.



.....  
*Note:* Time displays in 24-hour format only.

1. Click **Date & Time** in the Basic mode home screen.
2. Deselect **Enable** to set the time manually.

3. To synchronize the date and time automatically, click **Enable**.

#### 4. Click **Submit**.

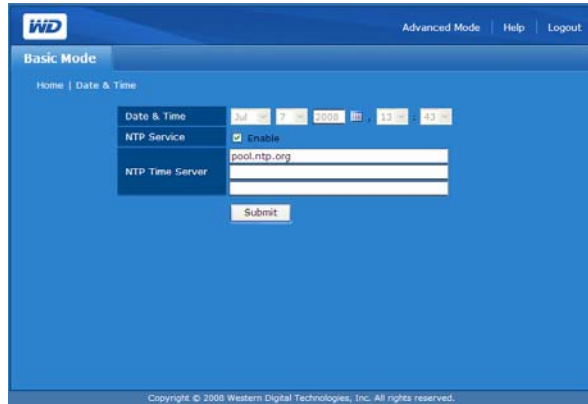

The screenshot shows the 'Basic Mode' configuration page for 'Date & Time'. The page has a blue header with the WD logo and navigation links for 'Advanced Mode', 'Help', and 'Logout'. Below the header, there is a 'Home | Date & Time' breadcrumb. The main content area contains a form with the following fields: 'Date & Time' (set to 'Fri 7:00:00 2008 10:43'), 'NTP Service' (checked 'Enable'), and 'NTP Time Server' (set to 'pool.ntp.org'). A 'Submit' button is located at the bottom of the form. The footer of the page reads 'Copyright © 2008 Western Digital Technologies, Inc. All rights reserved.'

## Network

The device's network mode is set to **DHCP Client** by default, which is appropriate for most environments. By selecting **Static IP**, you can set the network mode and change the IP address, netmask, gateway, and DNS (Domain Name Service) server IP address.

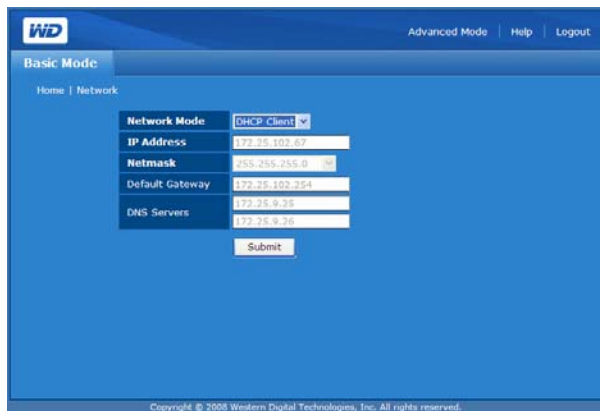

The screenshot shows the 'Basic Mode' configuration page for 'Network'. The page has a blue header with the WD logo and navigation links for 'Advanced Mode', 'Help', and 'Logout'. Below the header, there is a 'Home | Network' breadcrumb. The main content area contains a form with the following fields: 'Network Mode' (set to 'DHCP Client'), 'IP Address' (set to '172.25.102.67'), 'Netmask' (set to '255.255.255.0'), 'Default Gateway' (set to '172.25.102.254'), and 'DNS Servers' (set to '172.25.9.25'). A 'Submit' button is located at the bottom of the form. The footer of the page reads 'Copyright © 2008 Western Digital Technologies, Inc. All rights reserved.'

#### To configure the network settings:

1. Click **Network** in the Basic mode home screen.
2. In the Network Mode drop-down menu, select a network mode. Selecting **DHCP Client** as a network mode causes the device to obtain an IP address automatically from the local DHCP server. Selecting **Static IP** as a network mode requires you to enter IP information such as IP address, Default Gateway, and DNS Servers.
3. Click **Submit**.

## Users

Creating users allows the administrator to share data on My Book World Edition across the network by creating user accounts. The administrator can also edit and delete user accounts in the **Users** menu.



### Users Screen Icons

Icon	Description
	Denotes a user private share.
	This user is NOT set up as a private share.
	This user IS set up as a private share.
	Click this icon to change the user password.
	Click this icon to delete a user.
	Click this icon to add a user.

#### To create a new user account:

1. Click **Users** in the basic mode home screen.
2. Click the Add icon .
3. Enter the user name in the **User Name** field.
4. Enter the user's full name in the **Full Name** field.
5. Enter the password in the **Password** field.



.....  
*Note:* The user name and password can contain up to 15 characters, including alphabetic, numeric, underscore, space, and most special characters.

6. Re-enter the password in the **Confirm Password** field.
7. Create a private user share at the same time by clicking **Yes** next to **Create User Private Share**. The new user is granted full access to the private share. The private share name is the same as the user name.

8. Click **Submit**.

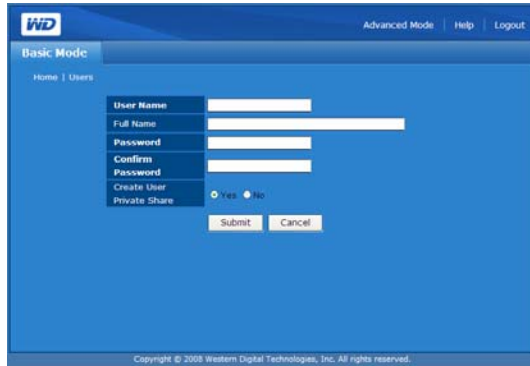

**To change a user password:**

1. Click the Change Password icon  next to the appropriate user account.
2. Make the necessary changes, and then click **Submit**.

**To delete an existing user account:**

1. Select the user account you want to delete, and then click the Delete icon .
2. Click **OK**.

For more user configuration options using the Network Storage Manager advanced mode, see “Users” on page 107.

**Folder Shares**

Shares are folders that can be used to organize and store files on your My Book World Edition network storage system. Shares can be shared with everyone (public) or with selected users on your network (private).

The device comes preconfigured with three shares:

- **Public**—created automatically after initial setup
  - Shared Music - folder for storing music files you want to share with other users.
  - Shared Pictures - folder for storing image files you want to share with other users.
  - Shared Videos - for storing video files you want to share with other users.



.....  
**Important:** Do not change or delete these default share folders. Disruption of file sharing could result. These are the default folders for the Media Server (Twonky Media) and iTunes Service. For more information on how to use Twonky media, see “Media Server” on page 105. For more information on how to use the iTunes service, see “iTunes” on page 105.

- **Download**—for saving files using Downloader (see “Scheduled Downloads” on page 118).
- **Configuration**—this is a read-only share containing only a Help file and the login page. It is not meant for sharing or storing data and should not be modified.

The administrator can create private shares accessible only by user name and password when setting up a user account (see “To create a new user account:” on

page 65), or by setting permissions on an existing share (see “Folder Share Permissions” on page 110).

You must first access Network Storage Manager to create a share. See “Accessing Network Storage Manager” on page 58.

The Folder Shares menu provides access to a list of available shares.



### Folder Shares Screen Icons

Icon	Description
	Denotes a user private share.
	This user is NOT set up as a private share.
	This user IS set up as a private share.
	Click this icon to delete a share.
	Click this icon to add a share.

### To create a share:

1. Click **Folder Shares** in the Basic mode home screen.
2. Click the Add icon .
3. Enter a share name in the **Share** field. The share name can contain up to 32 characters, including alphabetic, numeric, or underscore characters.
4. Enter a brief description in the **Description** field.

5. Click **Submit**.

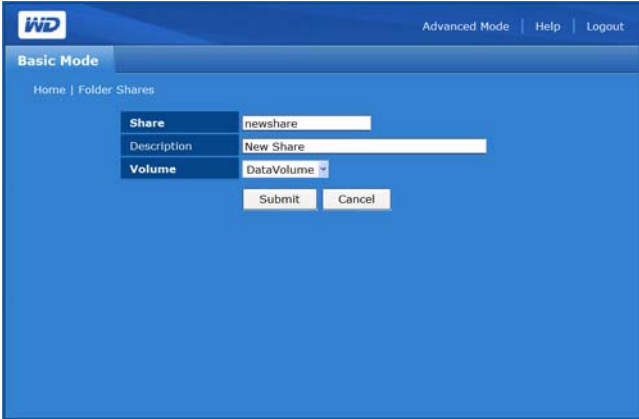

To delete existing shares:

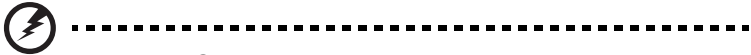

.....  
**WARNING: Deleting a share erases all data on the share. All files and folders on the share will be lost.**

- 1. Select the share to delete.
- 2. Click the Delete icon .
- 3. Click **OK**.

**System Status**

The System Status option displays general information about the system, such as device name, firmware version, current date/time, system uptime, IP address, volume usage, and volume RAID type. Click System Status in the basic mode home screen to access system information

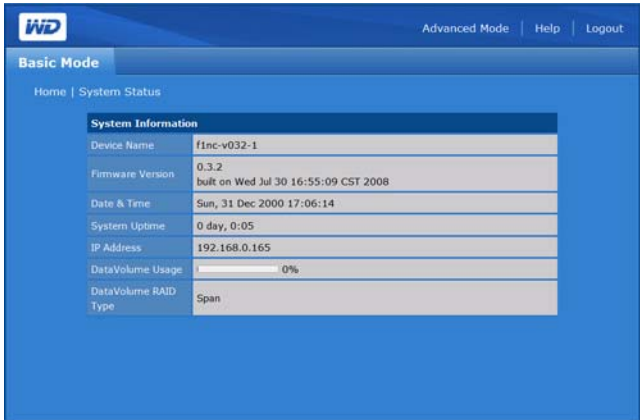

## Remote Access

My Book World Edition comes with MioNet enabled by default. The **Remote Access** menu allows you to configure the MioNet service on the storage device,

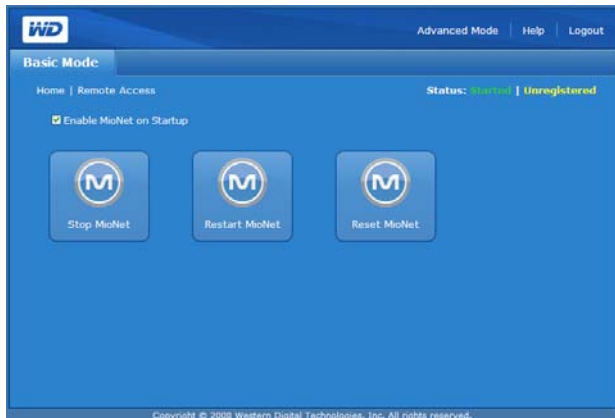

MioNet service status messages:

- MioNet service connection status
  - Started - MioNet service is started
  - Stopped - MioNet service is stopped and will start on system restart.
  - Disabled - MioNet service is disabled and will not start on system restart.
- MioNet registration status
  - Unregistered - Not currently registered to a MioNet account
  - Registered - Already registered to a MioNet account



.....  
 Note: A mouse-over of the registration status shows the MioNet account name if the device is registered. To register with MioNet, go to: [www.mionet.com/MyBookWorld](http://www.mionet.com/MyBookWorld).

## Shutdown/Reboot

The Shutdown/Reboot menu allows you to perform a system reboot or shutdown.

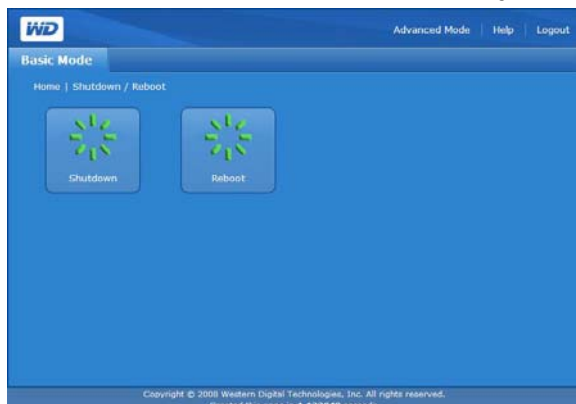

**To perform network storage system shutdown:**

1. Click **Shutdown/Reboot** in the basic mode home screen.
2. On the Shutdown/Reboot page, click **Shutdown**.

3. Click **OK**.

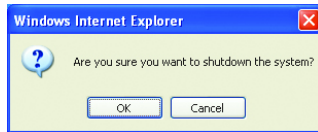

**To perform network storage system reboot:**

1. Click **Shutdown/Reboot** in the basic mode home screen.
2. On the Shutdown/Reboot page, click **Reboot**.
3. Click **OK**.

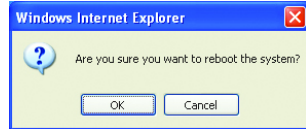

## Advanced Mode

Advanced mode provides access to additional options not available in the basic mode. When in basic mode, click **Advanced Mode** on the toolbar to view Network Storage Manager in advanced mode.

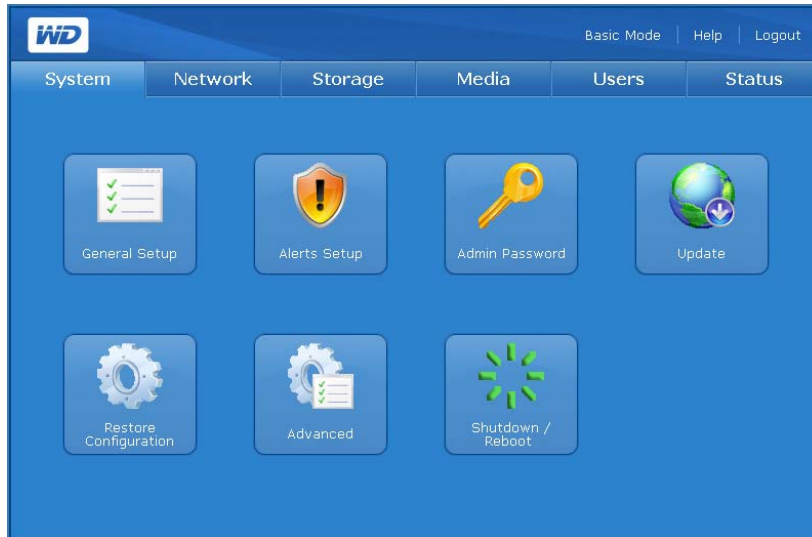

The advanced mode page include six tabs, each subdivided into several menu buttons providing more management options for maximum flexibility and security of the device. The table below describes the tab options available in advanced mode.

Tab	Description
System	The System tab allows you to configure the general system settings, set e-mail or window alerts, change the administrator password, perform firmware upgrades, perform system configuration file backups, restore system to factory defaults, activate or deactivate the system LEDs, generate an SSL certificate, enable power saving, and perform device shutdown or reboot. For more details, see “System” on page 72.
Network	The Network tab has access to all network configuration options, such as setting DHCP / Static, changing the IP address, netmask, gateway, DNS server IP address, configure jumbo frame size feature, and configuring membership in a domain or workgroup. For more details “Network” on page 85.
Storage	The Storage tab provides a list of all supported drives it locates on the system. It also allows you to configure the RAID capability of the hard drives (My Book World Edition II only), manage file share preferences, set the backup destination folder, set disk quotas, and set a share folder for users. For more details, see “Storage” on page 91.
Media	The Media tab allows you to enable or disable the streaming option in iTunes or access the Twonky Media server. For more details, see “Media” on page 104.
Users	The Users tab allows you to add, modify, and delete users and groups, and change all user and group permissions (read/write, read only, no access) to shares/folders and USB storage devices. For more details, see “Users” on page 107.
Status	The Status tab displays general information about the system such as device name, firmware version, current date/time, machine up-time, memory and swap activity, and load averages. This tab also allows viewing of logs from the system, Common Internet File System (CIFS), or File Transfer Protocol (FTP). For more details, “Status” on page 113.

## System

The System tab allows you to set the system date and time, set up alerts, change the admin password, perform software or firmware upgrades, create a backup copy of the system files, restore system to factory defaults, generate and set up an SSL certificate, or perform system reboot or shutdown.

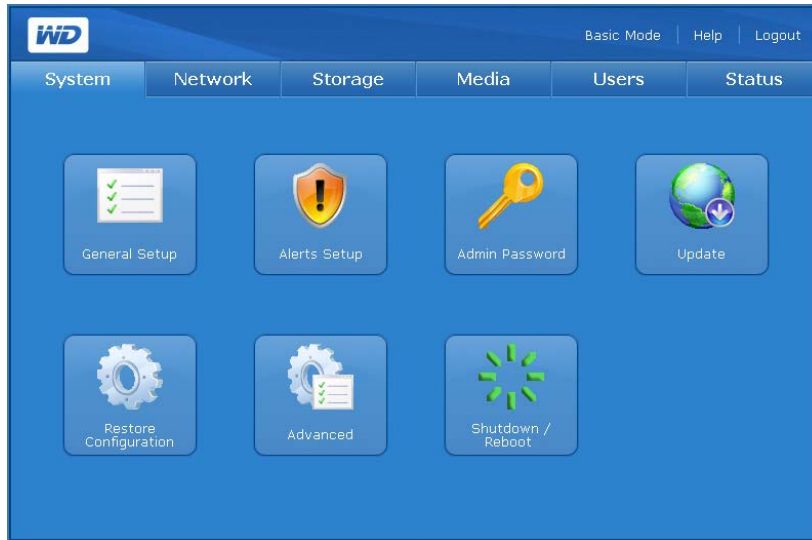

The System tab provides access to the following configuration options:

- General Setup
- Alerts Setup
- Admin Password
- Update
- Restore Configuration
- Advanced
- Shutdown/Reboot

## General Setup

The General Setup submenu allows you to perform basic configuration of device. Here, you can provide a name and brief description for the device, select a compatible web access protocol, and set the time zone. You can set the date and time manually or enable automatic time synchronization via NTP (Network Time Protocol) Service. You can also manually specify the IP address of the NTP servers to which you want to synchronize.

The screenshot shows the 'General Setup' configuration page for a WD device. The page has a blue header with the WD logo and navigation links for 'Basic Mode', 'Help', and 'Logout'. Below the header are tabs for 'System', 'Network', 'Storage', 'Media', 'Users', and 'Status'. The 'System' tab is active, showing the 'General Setup' page. The form contains the following fields:

- Device Name:** MyBookWorld
- Device Description:** My Book World Edition Network Storage
- Web Access Protocol:** HTTP (selected), HTTPS
- Time Zone:** (GMT-08:00) Pacific Time (US & Canada); Tijuana
- Date & Time:** Sep 22 2008 15:09
- NTP Service:**  Enable
- NTP Time Server:** pool.ntp.org

A 'Submit' button is located at the bottom of the form.

### To configure system general setup settings:

1. Assign a device name for this storage device in the Device Name field. The device name can contain up to 15 characters, including alphabetic, numeric, space, and most special characters.
2. Enter the brief description for this storage device in the Device Description field. The maximum length of the description must not be more than 256 alphanumeric characters.
3. In web access protocol, select either of the following web access protocols:
  - **Hypertext Transfer Protocol (HTTP)** is a communications protocol for the transfer of information on the intranet and the World Wide Web.
  - **Hypertext Transfer Protocol over Secure Socket Layer** or **HTTPS** is a URL scheme used to indicate a secure HTTP connection. It is syntactically identical to the http:// scheme normally used for accessing resources using HTTP. HTTPS provides a more secure means of configuring your device, but may affect the responsiveness of the user interface.
4. To set the date and time manually, deselect **Enable** next to NTP Service.
5. Select a time zone from the **Time Zone** list.
6. Adjust the date and time manually in the **Date & Time** lists.
7. Click **Submit**.

## Alerts Setup

Using the Alerts Setup submenu, you can configure e-mails or popup messages that provide alerts for system conditions, over temperature; hard drive, volume, network, and USB status; and user and group events. These alerts help the system administrator(s) manage and detect events or errors.



.....

*Note:* E-mail alerts may not work with some ISPs using strong spam filtering. For further information, go to [support.wdc.com](http://support.wdc.com) and search the knowledge base for answer ID 2570.

WD Basic Mode Help Logout

System Network Storage Media Users Status

Home | Alerts Setup

Email Notification  Enable

Pop-Up Notification  Enable

Submit

**Note:**

1. Please make sure all settings are valid by pressing the 'Send Test Mail' or 'Send Test Pop-up' buttons before submitting the changes.
2. Only computer name is allowed for 'Notified Devices'.
3. Pop-Up Notification applicable to Windows XP only.

### To set up automatic e-mail notifications:

1. Click **Enable** next to Email Notification.
2. Enter the name of the SMTP server or an IP address to be used for sending e-mail in the SMTP Server field (check with your ISP provider for the SMTP server name).
3. Enter the port number to be used when connected for SMTP sending in the SMTP Port field.
4. Click **Enable** next to SMTP Authentication if required, then enter the user name and password.
5. Enter the e-mail address where you want to send an e-mail message when an event occurs in the Email Recipients field. Up to five e-mail addresses can be added at a time.
6. Click **Send Test Mail** to send a test alert and confirm your settings are correct.

7. Click **Submit**.



**To configure alerts to send pop-up messages when an event occurs:**



.....  
*Note:* Pop-up notification only works with Windows XP.

For a list of events, see “System Events” on page 136.

1. On the Alerts Setup page, click **Enable** next to Pop-Up Notification.
2. Enter the name of the computer in the **Notified Devices** field. When an event occurs, a pop-up message will appear on the computer. Up to five computer names can be added to the alert list.



.....  
*Note:* To find the name of your computer, click **Start** and right-click **Computer** or **My Computer**, click **Properties**, and then click the **Computer Name** tab (Windows XP).

3. Click **Send Test Pop-up** to send a test alert and confirm that the settings are correct.



.....  
*Note:* Make sure the Messenger Service is activated on the computers to which you want to send the pop-up message when an event occurs. To enable Messenger Service, go to **Start > Control Panel > Administrative Tools > Services > Messenger**. You can test the Messenger Service by clicking **Send Test Pop-up**. Make sure printer and file sharing is selected as an exception if the Windows Firewall is enabled in Windows XP.

#### 4. Click **Submit**.

WD Basic Mode Help Logout

System Network Storage Media Users Status

Home | Alerts Setup

Email Notification  Enable

Pop-Up Notification  Enable

Notified Devices

Send Test Pop-Up

Submit

**Note:**

1. Please make sure all settings are valid by pressing the 'Send Test Mail' or 'Send Test Pop-up' buttons before submitting the changes.
2. Only computer name is allowed for 'Notified Devices'.
3. Pop-Up Notification applicable to Windows XP only.

### Admin Password

The Admin Password menu allows you to change the administrator's password.

WD Basic Mode Help Logout

System Network Storage Media Users Status

Home | Admin Password

Old Password

New Password

Confirm Password

Submit

Copyright © 2001 - 2008 Western Digital Corporation, All rights reserved.

#### To change the administrator's password:

1. In the **Old Password** field, enter the old password.
2. In the **New Password** field, enter the new password. The maximum length of the password must not be more than 16 alphanumeric characters. The password is case sensitive and should be entered exactly in the same way each time.
3. In the **Confirm Password** field, re-enter the new password.
4. Click **Submit**.

## Update (Firmware)

The Update menu provides information about the current firmware version and allows you to perform a firmware update either automatically or manually.

### Automated

The Automated tab provides information about the current firmware version and connects to the WD website for automatic downloading of the latest firmware.

1. Click **Check For New Firmware**.

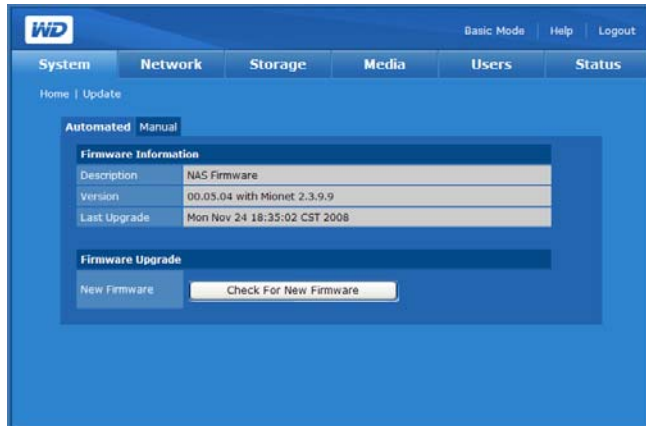

2. Click **Download** if new firmware is available.

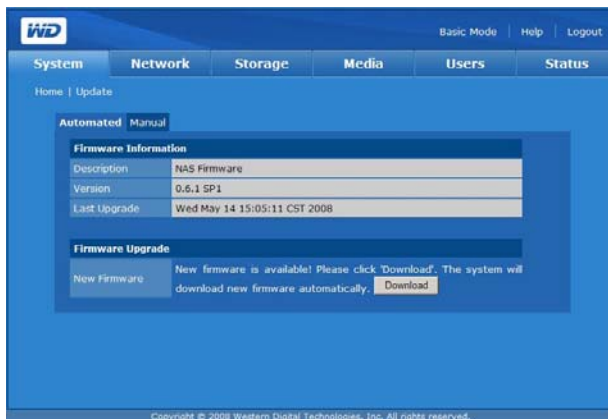

3. Click **Upgrade**. Wait for the update process to complete.



.....  
**Warning! Do not interrupt a firmware upgrade in progress, doing so may cause the device to malfunction or render it unable to boot.**

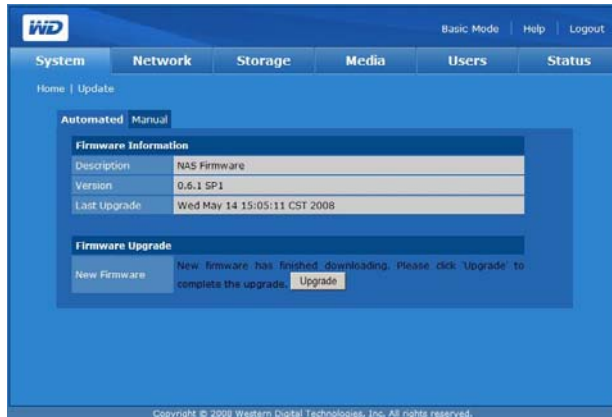

After your firmware has been updated, the device will reboot. The user interface redirects to the System Information page after the update has completed.

### Manual

The Manual tab allows you to install the firmware manually.

1. Download the latest firmware file from *support.wdc.com*.
2. Enter the path to the firmware file or click **Browse** to locate the file.



.....  
**Important:** Do not rename the firmware file.

3. Click **Submit** to transfer the firmware file from the computer to the network storage system. The update process may take a few minutes to complete.



.....  
**Warning! Do not interrupt a firmware upgrade in progress, doing so may cause the device to malfunction or render it unable to boot.**

After your firmware has been updated, the device will reboot. The web user interface redirects to the System Information page after the update is completed.

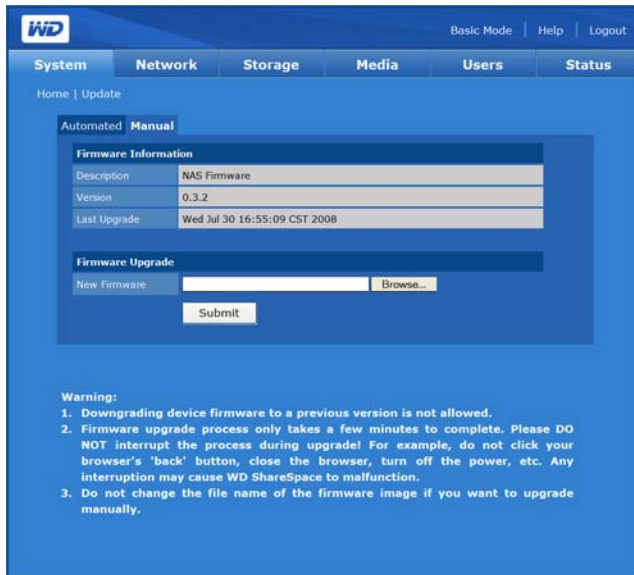

### Restore Configuration

The Restore Configuration menu allows you to save or restore system configuration settings or revert to factory default settings.

To back up the current system configuration settings:

1. On the Configuration page, click **Save Current Configuration**.

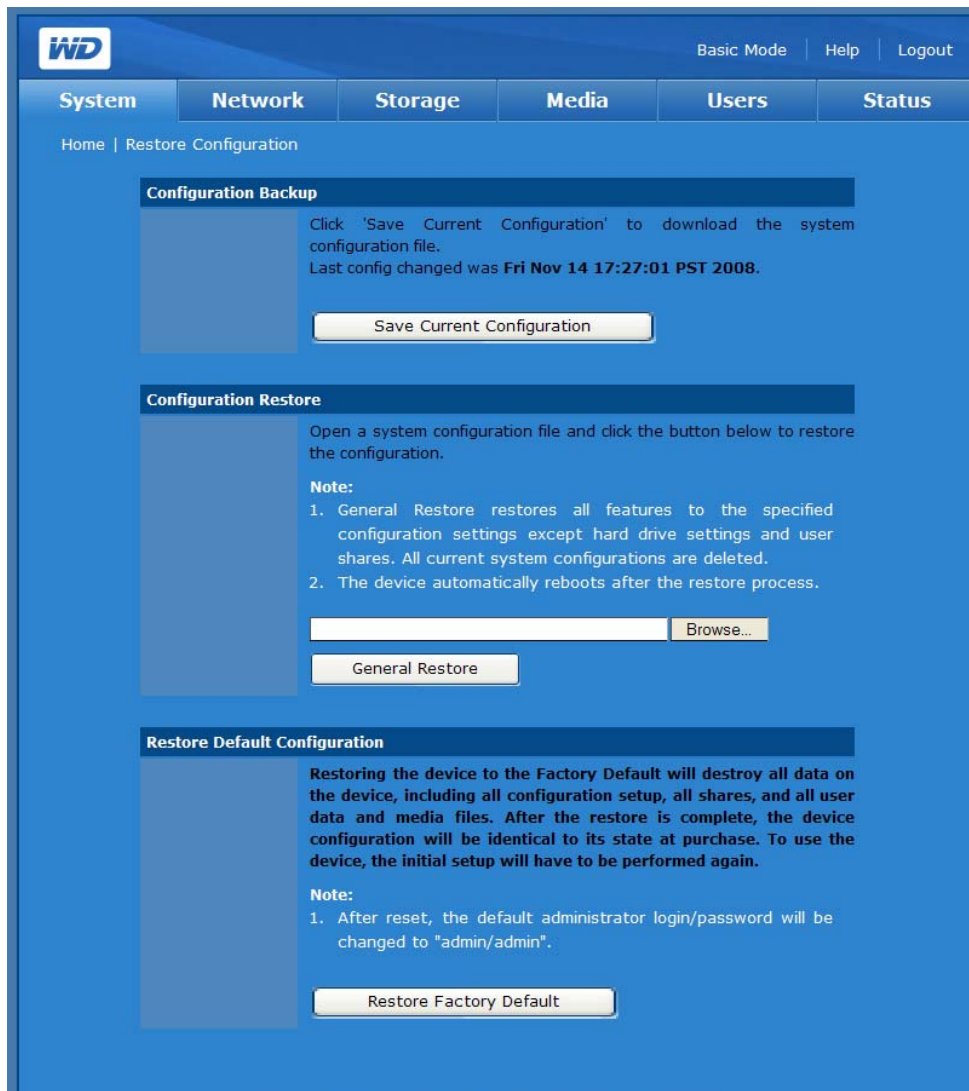

2. Click **Save**.
3. Specify a file name and location for saving the file.
4. Click **Save**.

To restore configuration settings:

1. On the Configuration page, click **Browse**.
2. Select the previously saved system configuration file.
3. Click **Open**.
4. Click **General Restore**. Selecting General Restore will restore all features to previously saved settings (data volume and shares settings excepted). All current system configurations will be lost.
5. Click **OK**.

**To restore the device to factory defaults:**

Performing a factory default reset will erase all settings in the network storage system. System configuration will reset the device to default factory settings. All information and data will be lost. The LAN settings (including port settings) are not changed. After the reset, the administrator login/password will be changed to "admin/admin."



.....

**Important:** Save the current configuration prior to restoring the factory default settings.

1. On the Configuration page, click **Restore Factory Default**.
2. Click **OK**.

During the system restore process, the system will turn off power LED and blink backup LED. Wait until the system restore process is completed.



.....

*Note:* You cannot access the configuration web pages if you forget the administrator password, IP address setting, or device name. Use the reset button to restore these settings (including IP setting, device name and administrator password) to factory default configuration. To use this function, press and hold the reset button on the back of the device (next to power interface) for at least 10 seconds. The system reboots automatically and you can then use the default settings to access the device.

**Advanced**

Configure the system for root access, SSL certificate/key, power saving, and LED control using the Advanced menu.

**To enable SSH access:**

Enabling SSH access allows login to a console window using SSH for diagnostic use. The default root user password is displayed for the user.

1. Click **Enable** under Root Access.
2. Click **Submit**.

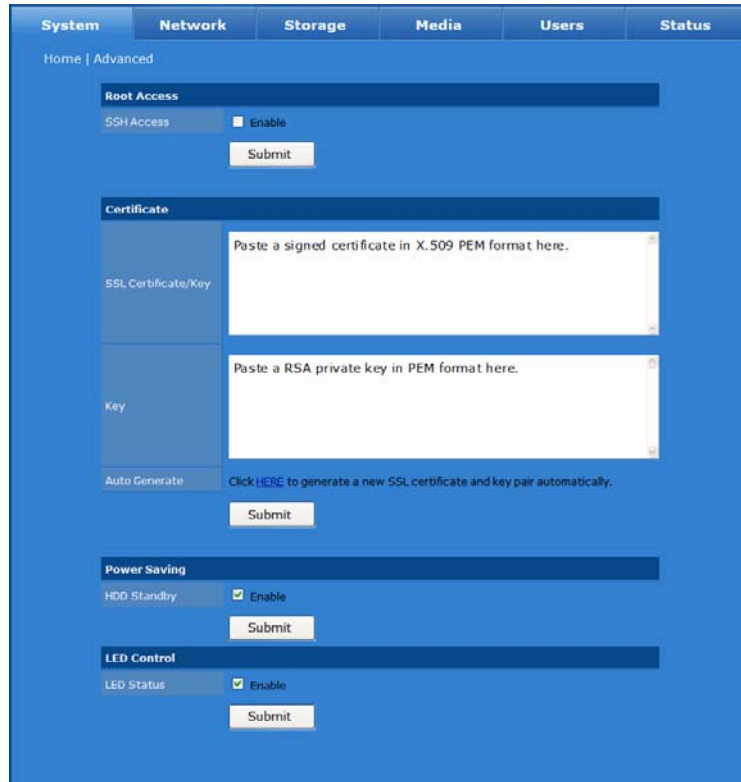

**To generate an SSL certificate and key pair automatically:**

Configure the system for a secure connection by generating a key and an SSL certificate automatically or manually using the Advanced menu.

1. On the Advanced Setup page, click the highlighted word **HERE**. The SSL Certificate/Key Generation dialog appears.



2. Enter the identification information you want to include in the SSL certificate/key pair, and then click **Submit**.

**To generate a SSL certificate and key pair manually:**

1. Generate a RSA private key.
2. Generate a RSA private key by typing the following commands on a Linux system (e.g. Redhat or Fedora).

```
/usr/bin/openssl genrsa 1024 > server.key
```

```
/bin/cat server.key
```

3. Copy and paste to the **Key** field of SSL certificate/key on the Advanced Setup page.
4. Create a self-signed certificate by typing the following commands:

```
/usr/bin/openssl req -new -key server.key -x509 -out server.crt
```

```
/bin/cat server.crt
```

5. Copy and paste to the **Certificate** field of SSL certificate/key on the Advanced Setup page.
6. Click **Submit**.

**To enable HDD standby:**

If the HDD Standby function is enabled, the hard drives go into standby mode to save power after a fixed period of no activity. This period varies from two to seven minutes.

1. Click **Enable** next to HDD Standby.
2. Click **Submit**.

**To enable LED control:**

The LED indicator function can be enabled or disabled using LED control. LED status is enabled by default. Follow these steps to turn off LED control:

1. Uncheck **Enable** next to LED Status.
2. Click **Submit**.

**Shutdown/Reboot**

The Shutdown/Reboot menu allows you to perform system reboot or shutdown.

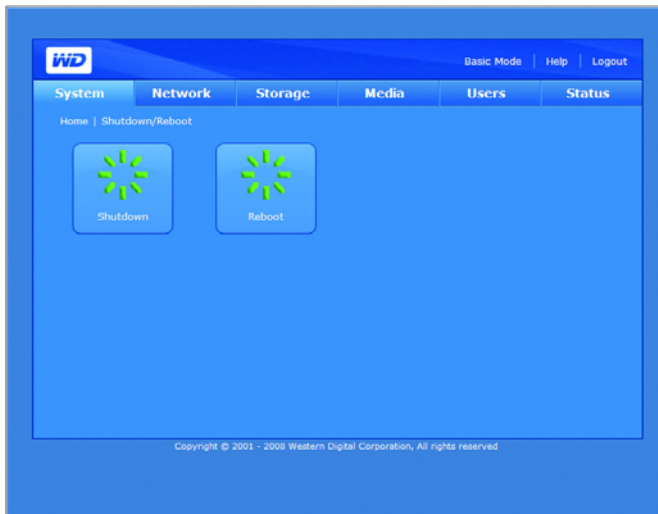

**To perform network storage system shutdown:**

1. Click **Shutdown/Reboot** in the **System** tab home screen.
2. On the Shutdown/Reboot page, click **Shutdown**.
3. Click **OK**.

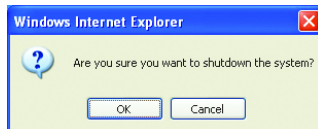

**To perform network storage system reboot:**

1. Click **Shutdown/Reboot** in the **System** tab home screen.
2. On the Shutdown/Reboot page, click **Reboot**.
3. Click **OK**.

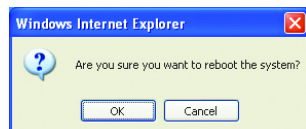

## Network

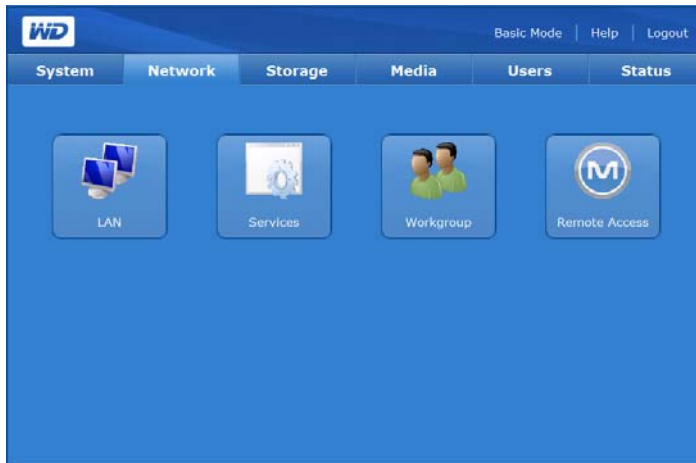

The Network tab provides access to the following configuration options:

- LAN
- Services
- Workgroup
- Remote Access

### LAN

The LAN submenu allows access to all network configuration options including setting the connection method, changing the IP address, netmask, gateway, and DNS (Domain Name Service) server IP address, and enabling the jumbo frame feature.



**To configure the network settings:**



.....  
*Note:* If connected to a home network, contact the Internet Service Provider (ISP) to obtain the static IP address.

1. In the Network Mode drop-down menu, select a network mode. Selecting DHCP Client as a network mode will cause this storage device to obtain an IP address automatically from the local DHCP server. Selecting Static IP as a network mode requires you to assign IP information such as IP address, Default Gateway, and DNS Servers.
2. If your network link speed is 1000 Mbps in the MTU Size menu, enter the MTU (Maximum Transmission Unit) value for the jumbo frame. The default MTU setting for Jumbo Frames is 1500 bytes. The network card on the client computer must support jumbo frame.



.....  
*Note:* For the MTU size larger than '1500', the client machine and the network switch must also support the same MTU size. The common MTU size for jumbo frame is '9004'. The rule for calculating valid MTU is  $(MTU\ size - 1500) \bmod 8 = 0$  ('xxx mod 8' means the value 'xxx' can be divided by 8).

The range of valid IP addresses for each class:

- Class A: 1.0.0.1 to 126.255.255.254
- Class B: 128.1.0.1 to 191.255.255.254
- Class C: 192.0.1.1 to 223.255.254.254

3. Click **Submit**.



**To enable UPnP NAT Traversal for Web Access & FTP:**

1. Click **Enable** in UPnP for Web Access & FTP.
2. Click **Submit**.

The UPnP NAT Traversal combines with the UPnP feature and NAT feature. Universal Plug and Play (UPnP) is an architecture for pervasive peer-to-peer network connectivity of PCs and intelligent devices. The Network Address Translation (NAT) is used in gateway devices that form the boundary between the public Internet and the private LAN. As IP packets from the private LAN traverse the gateway, NAT translates a private IP address and port number to a public IP address and port number, tracking those translations to keep individual sessions intact.

**To enable a network service:**

1. Click **Enable** in network service.
2. If you have selected **FTP** as your network service, click **Yes** to enable or click **No** to disable anonymous login, and then click **Submit**.
3. If you have selected **NFS** or **AFP** as your network service, the IP allowed field appears. You will be prompted to enter the IP filters that are allowed for NFS service. Click **Add** to add a new IP filter, and then click **Submit**.
4. You can specify particular port numbers for **HTTP**, **HTTPS**, and **FTP** services respectively. Instead of selecting the **Default** radio button, you can specify the port number between 8000 and 10000 for each service.



.....

*Note:* In IP Allowed field of NFS service, '\*' means allow all IP addresses. If you intend to allow specified IP addresses or range, please modify '\*' in IP Allowed field.  
Mount point for NFS share is /nfs/SHARENAME, Ex. /nfs/Public

**Workgroup**

The Workgroup menu allows you to set up the network storage device as a workgroup or a domain member. The default setting is Workgroup. Unlike workgroups, domains are controlled from a central location (domain controller) and require central authentication before you can join them. Workgroups, in contrast, are much simpler to control. As long as you know the workgroup name, you can add any computer to a workgroup.

If your network uses a domain (i.e., has a Windows ADS), you may wish to connect this device as a domain member. When configured as a domain member, the device will ask the ADS to authenticate users. Therefore, as a domain member, the device provides user-level security.

When joining a domain, the device must be authorized by the domain's administrator. A user must enter the Domain Name, Domain Controller IP Address, Administrator Name, and Administrator Password for the authorization.

**To set up a workgroup name:**

1. Click **Workgroup**.
2. Enter a name for your workgroup in the Workgroup Name field.
3. Click **Submit**.

The screenshot shows the 'Network' configuration page in a blue-themed interface. At the top, there are navigation tabs: System, Network (selected), Storage, Media, Users, and Status. Below the tabs, there are links for 'Home' and 'Workgroup'. The main content area has a 'Mode' section with two radio buttons: 'Workgroup' (selected) and 'Domain Member'. Below this is a 'Workgroup Name' field containing the text 'WORKGROUP'. A 'Submit' button is located at the bottom of the form.

**To set up a domain name (Windows 2003 Server only):**

1. Click **Domain Member**.
2. Enter the domain name in the **Domain Name** field.
3. Enter the domain controller IP address in **Domain Controller IP Address** field.
4. Enter the Administrator name in the **Administrator** field.
5. Enter the Administrator password in the **Administrator Password** field.



.....  
*Note:* The local user and domain user share the same access control rights if the user name of the local and domain users are the same (FTP service excluded).

6. Click **Submit**.

The screenshot shows the 'Network' configuration page with the 'Domain Member' mode selected. The 'Mode' section has 'Domain Member' selected with a radio button. Below it are four input fields: 'Domain Name', 'Domain Controller IP Address', 'Administrator', and 'Administrator Password'. A 'Submit' button is at the bottom.

## Remote Access

My Book World Edition comes with MioNet enabled by default. If MioNet is not already installed on the client computer, follow the instructions under “Configuring My Book World Edition” on page 53. The **Remote Access** menu allows you to configure the MioNet service on the storage device,

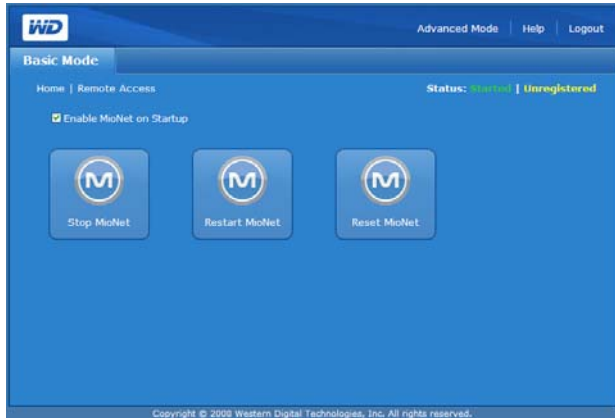

MioNet service status messages:

- MioNet service connection status
  - Started - MioNet service is started
  - Stopped - MioNet service is stopped and will start on system restart.
  - Disabled - MioNet service is disabled and will not start on system restart.
- MioNet registration status
  - Unregistered - Not currently registered to a MioNet account
  - Registered - Already registered to a MioNet account



.....  
*Note:* A mouse-over of the registration status shows the MioNet account name if the device is registered. To register with MioNet, go to: [www.mionet.com/MyBookWorld](http://www.mionet.com/MyBookWorld).

## Storage

The **Storage** tab provides all necessary options required for individual storage disk configuration and maintenance. This tab also includes an option to change the system's RAID configuration, set a share name, and format and safely remove the USB hard drives connected to the system.



The Storage tab provides the following configuration options:

- Disk Manager
- Volumes & RAID Management
- Folder Shares
- USB Shares
- Quota
- Downloads

## Disk Manager

The Disk Manager submenu displays the connected hard drives in the device. This submenu also displays detailed information about the hard drives, such as disk size, disk description, and status.

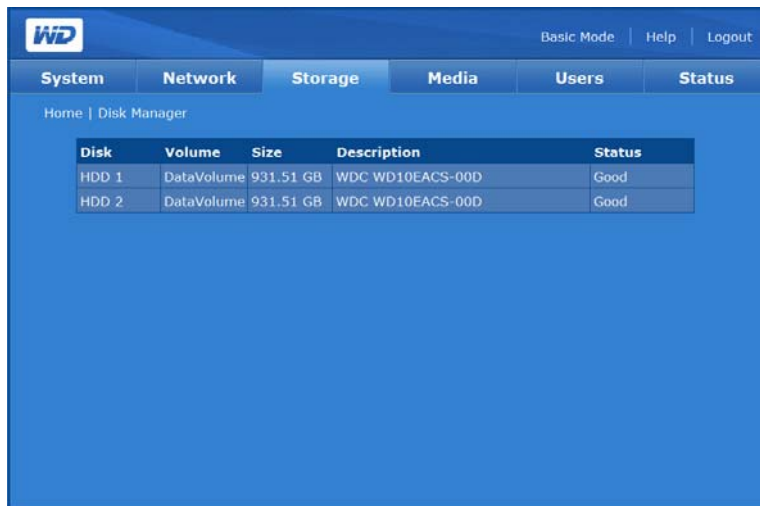

Drive status messages include the following:

- **Good**—Indicates the hard drive is accessible and functioning normally.
- **Failed**—Indicates a fatal error has occurred on the hard drive(s). See “Replacing a Drive (My Book World Edition II)” on page 128 for drive replacement instructions.
- **Foreign**—Indicates the device has detected a hard drive containing user data (e.g., the drive was used with another computer and contains data that is not recognized).

### To clean up disk:

If the hard drive is foreign or unused, the Clean Disk  icon appears on the right side of the Disk Management table. Clean Disk allows you to clean all data on the drive.

### To safely remove disk:

If the hard drive is unused, the Safely Remove Disk  icon appears on the right side of the Disk Management table, and allows you to safely remove the drive.

## Volumes and RAID Management

The Volumes menu includes two tabs—**Manage Volume** and **Manage RAID** (My Book World Edition II only).

### Manage Volume

The **Manage Volume** tab lists all the volumes available on the device and provides detailed information about each volume such as volume name, volume type (RAID type), disk or disks associated with the volume, usage, total size, and volume status.

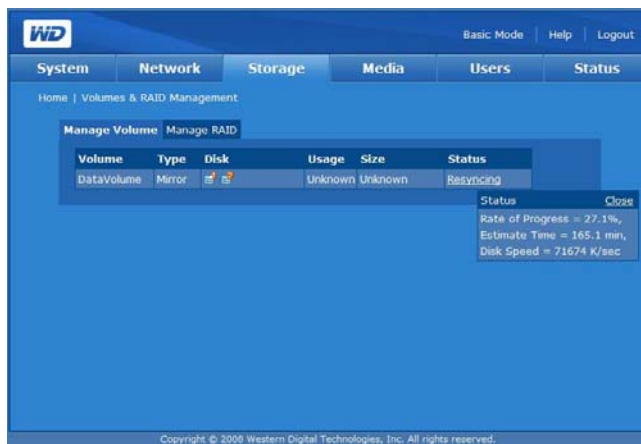

Volume status messages include the following:

- **Good**—Indicates the volume is accessible and hard drive is functioning normally.
- **Failed**—Indicates a volume cannot be started automatically, the disk may be damaged or the file system may be corrupt.
- **Resyncing**—Occurs when creating a mirror or when a mirrored volume is being resynchronized.
- **Formatting**—Indicates volume is being formatted or system is creating an ext3 (third extended) file system for a Linux operating system.
- **Degraded**—Missing one drive in a RAID 1 configuration.
- **Recovering**—The failed drive is being copied to a working drive in a RAID 1 (mirrored) configuration.

## Manage RAID (My Book World Edition II)

Configure RAID on the hard drives using the **Manage RAID** tab on the Volume Management submenu. The default RAID configuration is RAID 1 (Mirrored).



.....  
**WARNING! Changing the RAID configuration causes all volumes and data to be lost.**

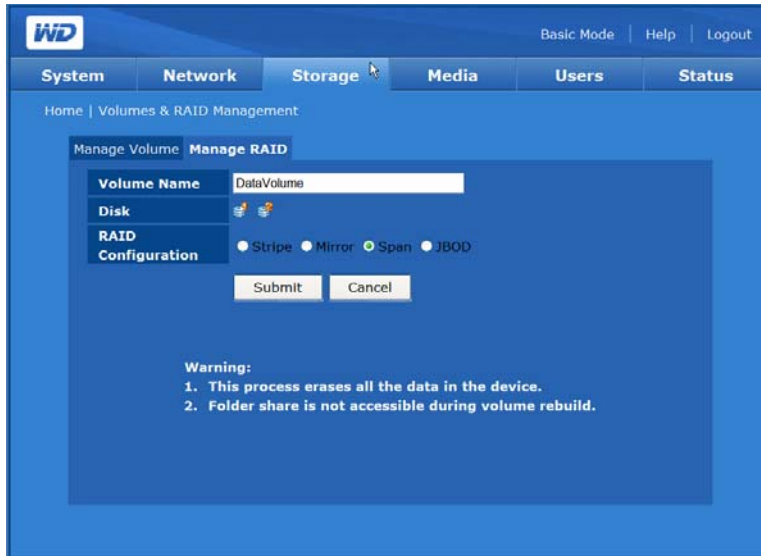

RAID (Redundant Array of Independent Drives) refers to an array of multiple independent hard drives that provide high performance and reliability. RAID function depends on the number of drives present and the RAID level selected.

The network storage system supports the following RAID levels:

- **RAID 0 (Striped)** - Provides data striping (spreading out blocks of each file across multiple hard drives) but no redundancy. This improves performance but does not deliver fault tolerance. If one drive fails then all data in the array is lost.
- **RAID 1 (Mirrored)** - Provides disk mirroring. Mirroring creates an exact copy (or mirror) of a set of data on two drives, which increases reliability compared to a single drive. If either drive fails, the other continues to function as a single drive until the failed drive is replaced. Note this RAID type has the highest disk overhead (100%) of all RAID types.
- **Span (Spanned)** - Combines drives into a linear fashion to create one large logical volume. Unlike RAID 0, which “stripes” all data bitwise to both drives, the volume is linear across both drives. A spanned drive is literally like a single bigger drive, in that files written to the volume earlier go to the “beginning” of the volume, on the first physical drive. As the volume fills, files written later are written toward the “end” of the volume, on the second drive. Like RAID 0, no data redundancy is provided. If one of the drives fails, all data is lost.
- **JBOD (Just a Bunch of Disks)** - In JBOD mode, two drives are provided as two separate volumes. This is the only mode on the My Book World Edition II for which there are two data volumes. If one of the drives in a JBOD volume fails, only the user data on that volume is lost.

**To configure the Manage RAID tab:**



.....  
*Note:* Be sure to back up all data before configuring RAID. All data stored in the hard drive is lost when changing the RAID configuration.

1. Click the **Manage RAID** tab.
2. Select a RAID configuration

DataVolume is the default volume.

If the volume RAID type is Span and there are new disks in the system, the Extend icon appears on the side of the Volume Management table.

3. Click **Submit**.

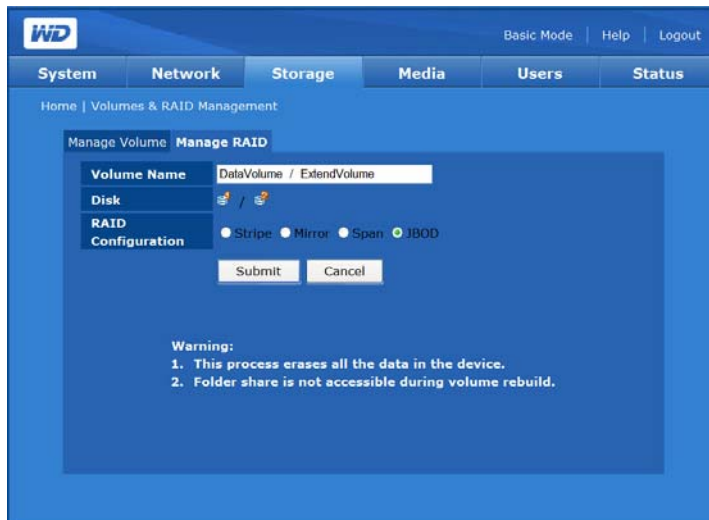

**Manage RAID Options (My Book World Edition II)**

Any existing mode can be changed to any other available mode using the Manage RAID option. The following table provides the available modes and data availability for a My Book World Edition II with one drive after adding a second drive.

Starting Configuration	Ending Configuration	User data condition after second drive added
JBOD (1 Volume)	Spanned (Linear)	Deleted
JBOD (1 Volume)	JBOD (two volumes)	Still available
JBOD (1 Volume)	RAID 0 (Striped)	Deleted
JBOD (one volume)	RAID 1 (Mirrored)	Deleted
RAID 1 (Mirrored)	Spanned (Linear)	Deleted
RAID 1 (Mirrored)	JBOD (two volumes)	Deleted
RAID 1 (Mirrored)	RAID 0 (Striped)	Deleted
RAID 1 (Mirrored)	RAID 1 (Mirrored)	Still available after rebuild

All “1 Drive” configurations for the My Book World Edition II are considered “Degraded” RAID modes. When a drive fails in a My Book World Edition II with two

drives, the following table applies regarding the user data on the remaining good drive.

Starting Configuration	User data condition after one drive fails
Span (Linear)	All user data is lost
JBOD	User data on good drive still accessible
RAID 0 (Striped)	All user data is lost
RAID 1 (Mirrored)	User data on good drive still accessible, but with no data redundancy

### Folder Shares

Shares are folders that can be used to organize and store files on your My Book World Edition. Shares can be shared with everyone (public) or with selected users on your network (private).

The device comes preconfigured with three shares:

- **Public**—created automatically after initial setup
  - Shared Music - folder for storing music files you want to share with other users.
  - Shared Pictures - folder for storing image files you want to share with other users.
  - Shared Videos - for storing video files you want to share with other users.



.....

**Important:** Do not change or delete these default share folders. Disruption of file sharing could result. These are the default folders for the Media Server (Twonky Media) and iTunes Service. For more information on how to use Twonky media, see “Media Server” on page 105. For more information on how to use the iTunes service, see “iTunes” on page 105.

- **Download**—for saving files using Downloader (see “Scheduled Downloads” on page 118).
- **Configuration**—this is a read-only share containing only a Help file and the login page. It is not meant for sharing or storing data and should not be modified.

The administrator can create private shares accessible only by user name and password when setting up a user account (see “To create a new user account:” on page 65), or by setting permissions on an existing share (see “Folder Share Permissions” on page 110).

The Folder Shares menu provides access to a list of available shares.

Share	Volume	CIFS	FTP	NFS	AFP
Download	DataVolume	✓	✓	✓	✓
Public	DataVolume	✓	✓	✓	✓
usb1-1share1	USB Disk 1-1	✓	✓	✗	✓

**Note:**

1. CIFS (Common Internet File System) Access - Allows access to share files via the CIFS protocol. The access control for CIFS is set as share folder-based. This means that a user must enter a valid account and password for accessing the share, and users can only access the shares to which they have been granted access rights (Read Only or Full Access). CIFS is the recommended file sharing protocol for Windows platform, and allows users to access shares through My Network Places. Mac OS X or later also supports the CIFS protocol support.
2. FTP (File Transfer Protocol) Access - Allows access to share files via the FTP protocol. Access control rights for the FTP protocol are the same as the CIFS protocol for each share folder. The FTP protocol is a platform-independent file sharing protocol, so the user can use any FTP client program to access shares.
3. NFS (Network File System) Access - Allows access to share files via the NFS protocol. NFS protocol access is controlled by a set of accepted IP addresses for each share folder. NFS is recommended for users of UNIX and similar systems.

USB share naming corresponds to the following configuration:  
usb1-<port number>share<partition number>

The port number is always “1” since My Book World Edition has only one USB port.

**To create a share on the volume:**

1. Click the Add icon .
2. Enter a share name in the **Share** field. The share name can contain up to 32 characters, including alphabetic, numeric, or underscore characters.
3. Enter a brief description in the **Description** field.
4. Click a file sharing protocol next to **Services**. The network storage system supports the following file sharing services (protocols):
  - **CIFS (Common Internet File System)** - Allows access to share files via the CIFS protocol. The access control for CIFS is set as share-based. This means that a user must enter a valid account and password for accessing the share, and users can only access the shares to which they have been granted access rights (Read Only or Full Access). CIFS is the recommended file sharing protocol for Windows platform, and allows users to access shares through My Network Places. Mac OS X or later also supports the CIFS protocol.
  - **File Transfer Protocol (FTP)** is a network protocol used to transfer data from one computer to another through a network, such as the internet, using an FTP client program. FTP is a popular choice for exchanging files independent of the operating systems involved.
  - **Network File System (NFS)** is a network file system protocol that allows a user on a client computer to access files over a network as easily as if the network devices were attached to its local disks.
  - **Apple File Protocol (AFP)** is a network protocol that offers file services for Mac computers.
5. Select a logical volume you want to share from the **Volume** list.
6. Click **Setup access control after creating this share** to set access control for the new share. For more information, see “To edit the access rights of users or groups:” on page 111.
7. Click **Submit**.

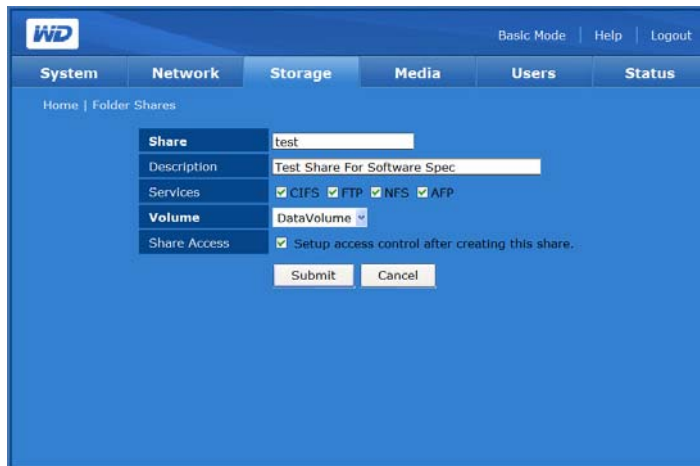

**To modify properties of the share:**



.....  
*Note:* Properties for the Public and Download shares cannot be modified and these shares cannot be deleted.

1. Select the share you want to modify, and then click the Modify icon .
2. Enter a new share name. The share name can contain up to 32 characters, including alphabetic, numeric, or underscore characters.

3. Enter a brief description.
4. Select a file sharing protocol.
5. Click **Submit**.

**To delete existing shares:**

1. Select the share to delete.
2. Click the Delete icon .
3. Click **OK**.

**USB Shares**

When a USB storage device with the FAT, HFS+, or NTFS file system is connected to the network storage device, the USB device will be displayed as a USB share.

**USB Disk**

Use the USB Disk tab to format and safely disconnect a USB hard drive or to format the USB hard drive.

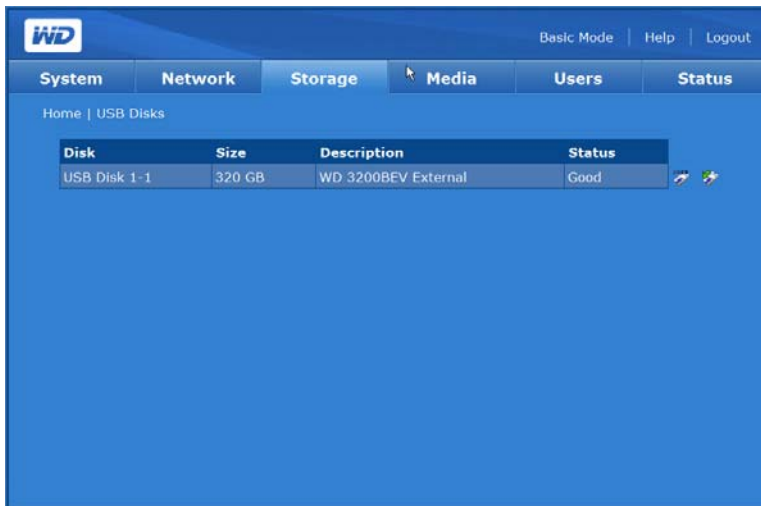

To format a USB hard drive:

1. Connect a USB hard drive to the device.



.....  
*Note:* The network storage system supports USB flash disk and external USB hard drives; USB optical drives (CD/DVD combo or DVD dual/multi drive) are not supported.

For instructions on how to connect a USB hard drive to the network storage system, see “Copy Manager” on page 123.

2. On the USB Management page, click the **USB Disk** tab.

3. Select the USB hard drive to format, and then click the Format icon . A dialog box appears warning that all data will be erased.

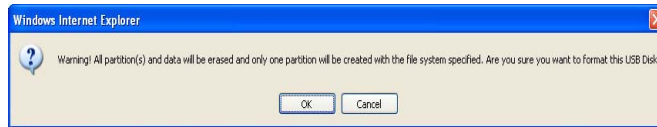

Warning! Formatting hard drives erases all the disk contents, including partition tables, logical volumes, and all shared folders and subfolders and files. Perform this procedure only when it is safe to proceed. When formatting a USB hard drive, only one partition is created and the partition is formatted as FAT32. With FAT32, only 4 GB can be copied for each file. If you try to transfer files that are larger than 4 GB, you may encounter a Copy Termination error.

4. Click **OK**.
5. Do not disconnect the USB hard drive from the network storage system until formatting is complete.

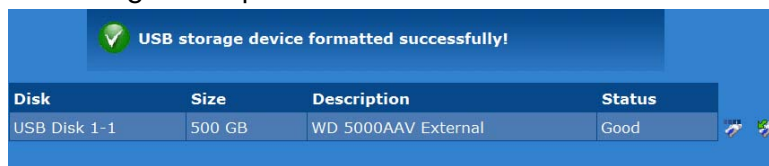

To safely remove a USB hard drive:



Note: Whenever a USB device is disconnected without first being ejected or dismantled, there is a risk of data loss or damage to the USB hard drive. With the safe remove disk option you can safely remove any USB hard drive attached to the device.

1. On the **USB Disk** tab, select a USB hard drive.
2. Click the Safely Remove Disk icon .

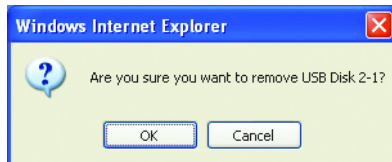

3. Click **OK**.

### Quota

The Quota menu allows administrators to enable or disable quota control for the device and set grace time and quota limits for each user.

Quota is used to limit the maximum storage capacity for each user. The accumulated file size used in a volume for the specified user cannot exceed the quota setting. Once the user data exceeds the quota, a 7-day (by default) grace period commences. The user still can store up to 100 MB of additional data on the volume within the grace period. When the grace period expires, the user cannot store

additional data on the volume until deleting the amount of data required to reduce the total used capacity below the quota setting.

### Manage Quota

The **Manage Quota** tab in the Quota Management menu provides the quota information for each volume and allows administrators to modify the quota settings.

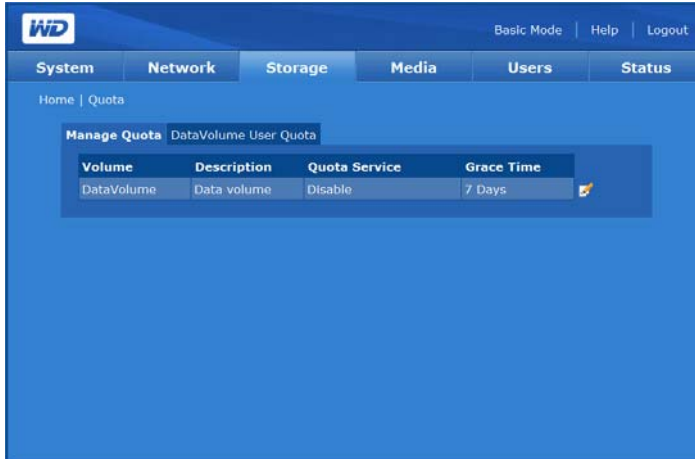

To configure disk quota:

1. Select the volume you want to modify, and then click the Modify icon .
2. Click **Enable** next to **Quota Service** to enable disk quota service.
3. Specify the grace period after which no additional drive space is provided.
4. Click **Submit**.

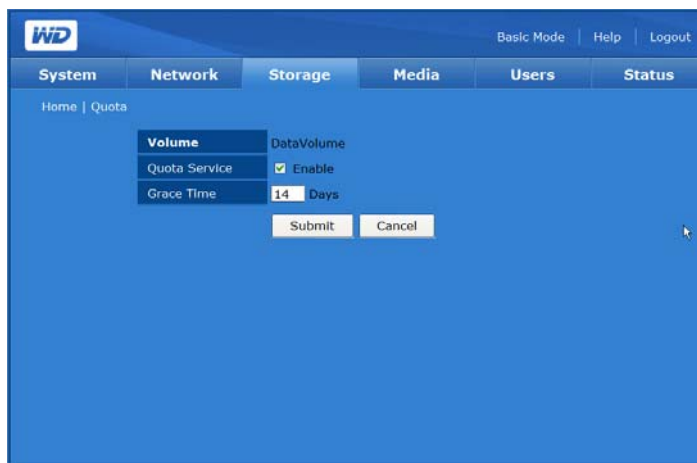

### DataVolume User Quota (or ExtendVolume User Quota)

The DataVolume **User Quota** (ExtendVolume User Quota) tab provides user quota information details and allows administrators to modify the user quota setting.



To modify the user quota setting:

1. Select the volume you want to modify, and then click the Modify icon.
2. Click **Enable** next to Quota Service to enable disk quota service.
3. Specify the amount of time the saved or backup files will be retained in the system.
4. Click **Submit**.

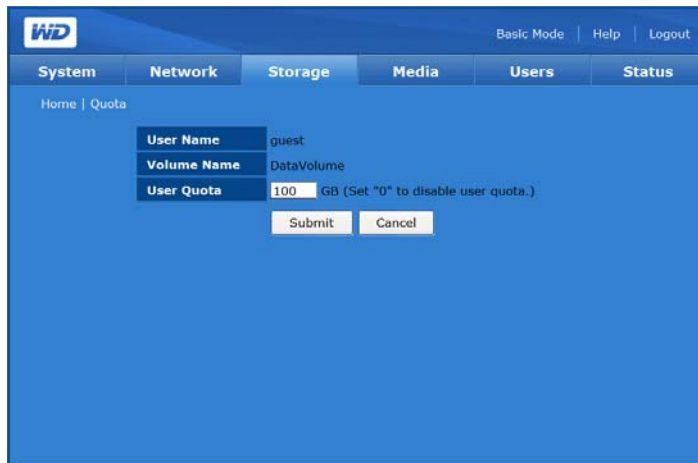

## Downloads

The Downloads menu includes two tabs—**Setup Destination Share** and **Change Password**. This menu provides configuration options for selecting the Downloads target share and changing the Downloader login password.

### Set up Destination Share

Use the **Setup Destination Share** tab to choose the target share for the Downloader utility. For more information on how to use the Downloader utility, refer to “Scheduled Downloads” on page 118.

To set the destination share name for the Downloader:

1. On the Downloads page, click the **Setup Destination Share** tab.
2. Select the folder to share with others from the **Destination Share** list.
3. Click **Submit**.

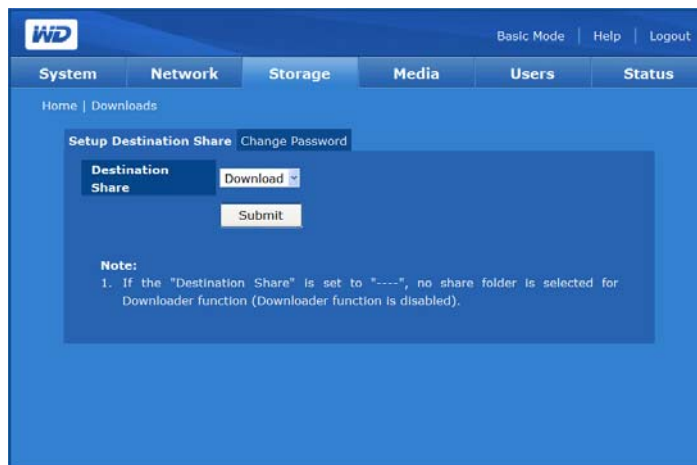

**Change Password**

The **Change Password** tab allows you to change the Downloader’s password.

To change the Downloader’s password:

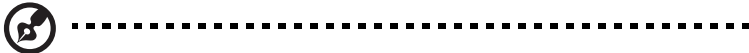

.....  
*Note:* The default password is “downloader.”

1. On the Downloads page, click the **Change Password** tab.
2. Enter a password in the Change Password field. The maximum length of the password must not be more than 16 alphanumeric characters.
3. Re-enter the password in the **Confirm Password** field.
4. Click **Submit**.

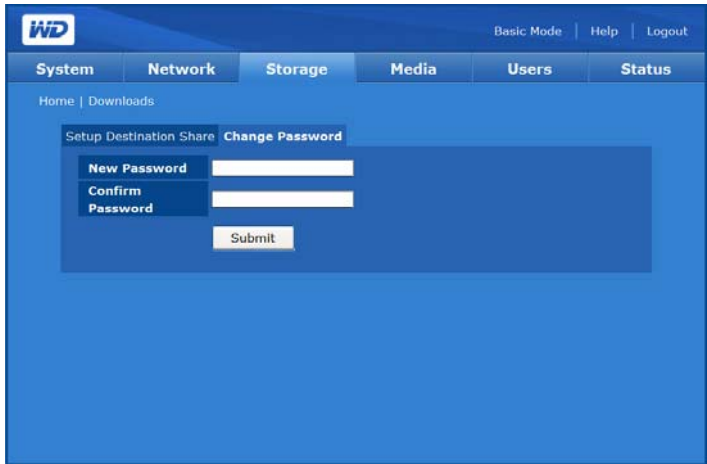

**Media**

The **Media** tab provides access to the iTunes and Media Server menus.

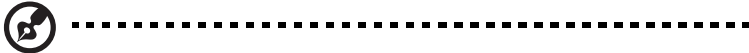
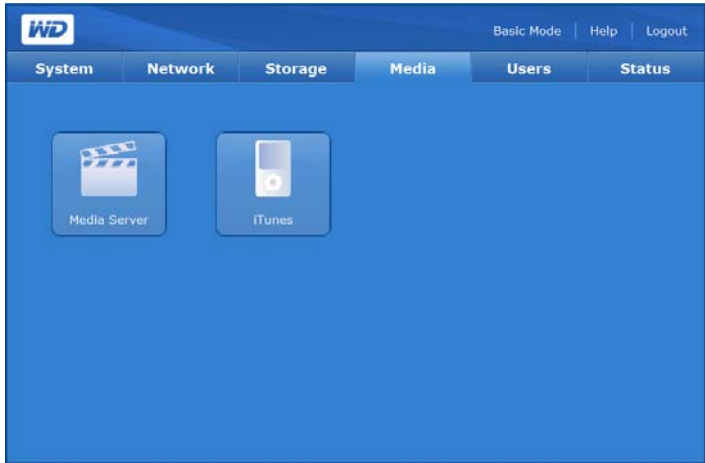

.....  
*Note:* Both the Media Server and the iTunes server only work on the LAN.

## Media Server



-----  
*Note:* It is not mandatory to access the Twonky Media server to search for or play media files.

The Twonky Media server application searches for all the media (for example, videos, photos, and music) stored on the My Book World Edition connected to your home network. The server is pre-set, so you can just transfer your multimedia content to the respective shared folders on your My Book World Edition, and you are ready to stream and view content on your home entertainment center, game consoles (for example, XBOX 360, Playstation 3, or DLNA 1.5 Digital Media Adapters), and other PCs on your home network. Visit [www.twonkymedia.com](http://www.twonkymedia.com) for further information on Twonky Media.

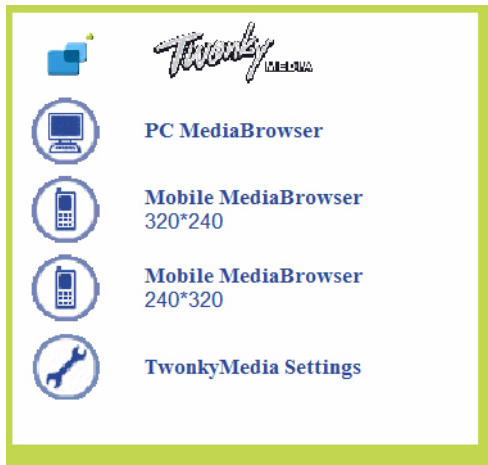

## iTunes

Enable the iTunes Server Service and customize the service settings using the **iTunes** menu. iTunes Server Service allows iPod and iTunes users to share and play music on the network storage system.



-----  
*Note:* iTunes service is enabled by default.

When the iTunes Service is enabled in the Network Storage Manager, you or anyone connected to the network storage system can play music files stored on the system using iTunes. This service creates a virtual music library on the device and treats it as an iTunes repository, making it possible for music files to stream from the network storage system to Windows or Mac computers running iTunes.

The iTunes Server Service supports the following file types:

- \*.mp3
- \*.wav
- \*.aac



-----  
*Note:* The iTunes server service requires the presence of the '/Public/Shared Music' share folder. Do not rename or delete Shared Music if you want to use the iTunes server. You must recreate or rename the '/Public/Shared Music' share if it has been deleted or renamed.

**To enable or disable the iTunes Server Service:**



.....  
*Note:* iTunes service is enabled by default.

1. On the iTunes Server Service page, click **Enable** next to iTunes Service. Or, deselect the option to disable it.
2. Specify how often iTunes can scan the device for new music files.
3. Click **Submit**.



**To customize media library update frequency:**

1. Click an option in the **Check for new music every** list.
2. Click **Submit**.

**To stream audio in iTunes:**

1. Make sure that the iTunes Service is enabled in the Network Storage Manager utility. See “To enable or disable the iTunes Server Service:” on page 106 for more information.
2. Click **MyBookWorld** under the Shared section of the left pane. If you have copied music to the /Public/Shared Music folder and it is in a format supported by iTunes, it should be listed in the right pane.
3. Double-click an audio file.

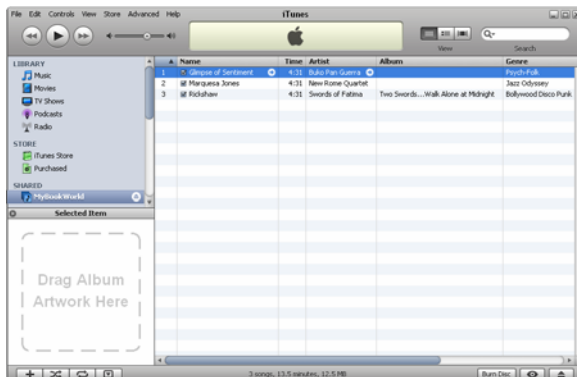

The audio file is streamed in iTunes and audio files from the network storage system are displayed under the Shared list.



.....  
*Note:* Both the Media Server and the iTunes server only work on the LAN.

## Users

The **Users** tab provides access to the following configuration options:

- Users
- Groups
- Folder Share Permissions
- USB Share Permissions



## Users

The Users menu allows administrators to create, edit, and delete user accounts from Access Control list management.

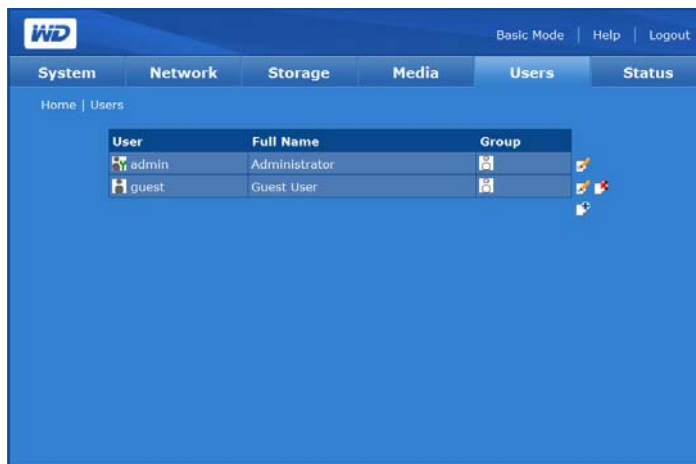

### To create a new user account:

With this feature, you can create user accounts on the network storage system and further customize these accounts with privilege levels.

1. Click the Add icon .



.....

*Note:* The user name and password can contain up to 15 characters, including alphabetic, numeric, underscore, space, and most special characters.

2. Click **Grant Administration Rights** to provide the user with administrative rights. Administration rights allow the user to configure the device.
3. Enter the user name in the **User Name** field.
4. Enter the user's full name in the **Full Name** field.
5. Enter the password in the **Password** field.
6. Re-enter the password in the **Confirm Password** field.
7. Select a previously created Group for the user to join from the Group List.
8. Click the **>>** button to add the selected user to the group.
9. Create a private user share at the same time by clicking **Yes** next to **Create User Private Share**. The new user is granted Full Access to the private share. The private share name is the same as the user name. Nobody else has access to this private share unless it is specifically granted by the administrator.
10. Select a volume that you want the user to access.
11. Select a file sharing protocol service.
12. Click **Submit**.

**To modify a user account:**

1. Select the user account to modify, and then click the Modify icon .
2. Make the necessary changes, and then click **Submit**.

**To delete an existing user account:**

1. Select the user account you want to delete, and then click the Delete icon .
2. Click **OK**.

## Groups

The **Groups** submenu allows the administrator to create, edit, and delete a group from Access Control list management.

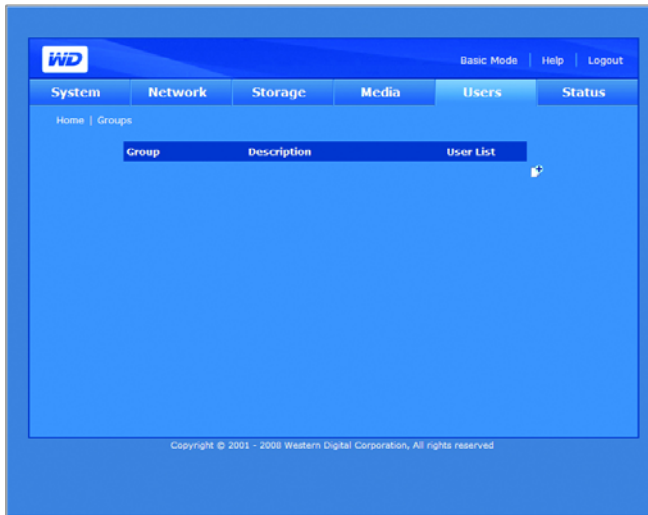

### To create a group account:

1. Click the Add icon .
2. Assign a new group name.
3. Enter a description of the new group.
4. Select a user from the User List field to add to the User Joined field.
5. Click the **>>** button.
6. Click **Submit**.

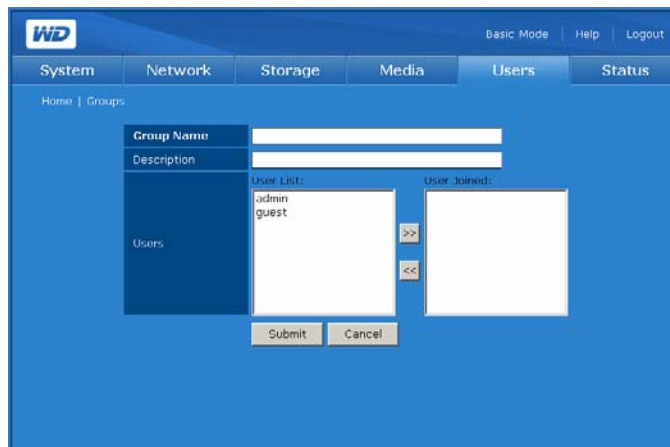

**To modify a local group:**

1. Select the group account you want to modify, and then click the Modify icon .
2. Make the necessary changes, and then click **Submit**.

**To delete a local group:**

1. Select the group you want to delete, and then click the Delete icon .
2. Click **OK**.

**Folder Share Permissions**

The Folder Shares menu allows you to set the access control for each user or group in the Access list.

- Public Access 
- Full Access 
- Read Only 
- Deny Access 
- Not Assigned 

When there is a conflict in the access rights of the user and group, the network storage system uses the following rules to handle the conflict:

- Deny Access will have the highest priority.
- Full Access + Read Only = Full Access.

If the access control is assigned to users or groups, the full access, read only, and no access icons appear on the Share Access page. You can move your mouse over the icon to view the user or group list.



**To edit the access rights of users or groups:**

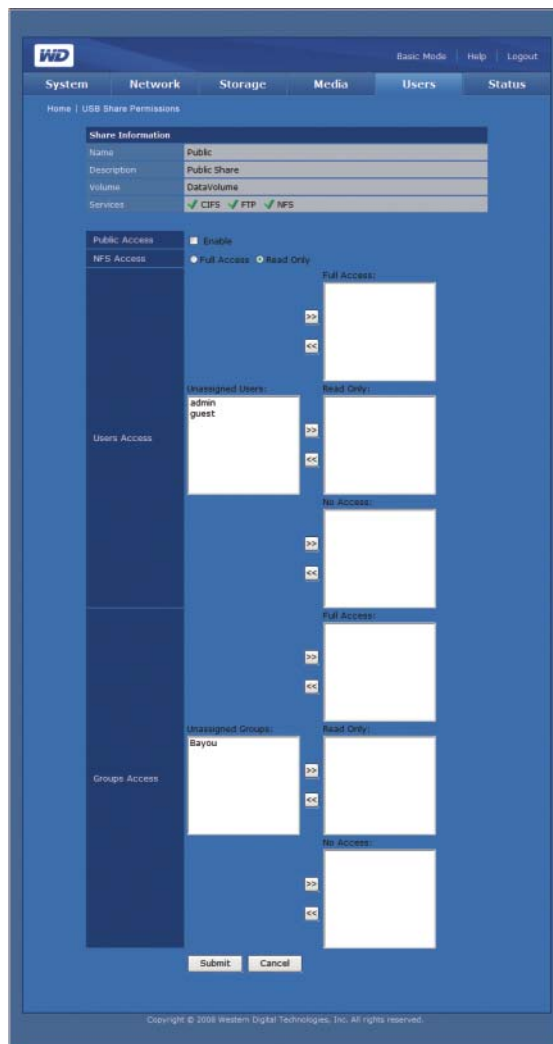

1. Select a user or group, and then click the Edit icon .
2. Click **Enable** next to Public Access allow everyone to access to the share.
3. Select an access option.
4. In the **Not Assigned Users** list, select the users to whom you want to grant full access, read only permission, or no access to the share.
5. Click the >> button.
6. In the **Not Assigned Groups** list, select the local groups to which you want to grant full access, read only permission, or no access to the share.
7. Click the >> button.
8. Click **Submit**.



## USB Share Permissions

Use the USB Shares menu allows to set access control for the two USB ports on the back of the device.

The three types of access control that you can assign to a user or group include:

- Full Access 
- Read Only 
- Deny Access 

When there is a conflict in the access rights of the user and group, the device uses the following rules to handle the conflict:

- Deny Access will have the highest priority.
- Full Access + Read Only = Full Access.

If the access control is assigned to users or groups, the full access, read only, and no access icons appear on the Share Access page. You can move your mouse over the icon to view the user or group list.

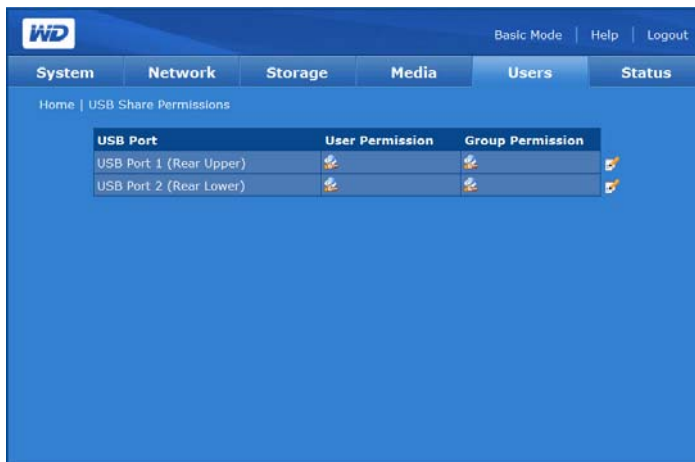

### To edit the access rights of users or groups:

1. Select the share you want to modify, and then click the Edit  icon.
2. Click **Enable** next to **Public Access** to allow everyone to access the share.
3. Select an access option.
4. In the **Not Assigned Users** list, select the users to whom you want to grant full access, read only permission, or no access to the share.
5. Click the >> button.
6. In the **Not Assigned Groups** list, select the local groups to which you want to grant full access, read only permission, or no access to the share.
7. Click the >> button.
8. Click **Submit**.

## Status

The **Status** tab provides access to the following configuration options.

- System Status
- System Logs

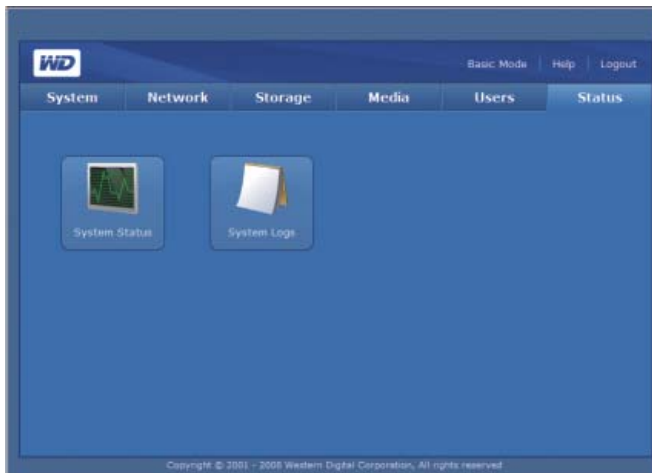

### System Status

The System Status menu displays general information about the system, such as device name, version, current date/time, system uptime, IP address, volume usage, and volume RAID type.



### System Logs

The System Logs submenu displays the events recorded by the System Configuration utility. You can view information such as file and services requested on the device, requests and records between the device and client computers, or printer events. You can also change the order and number of the log entries shown in log pages.

## System

The System tab displays system logs on the device.

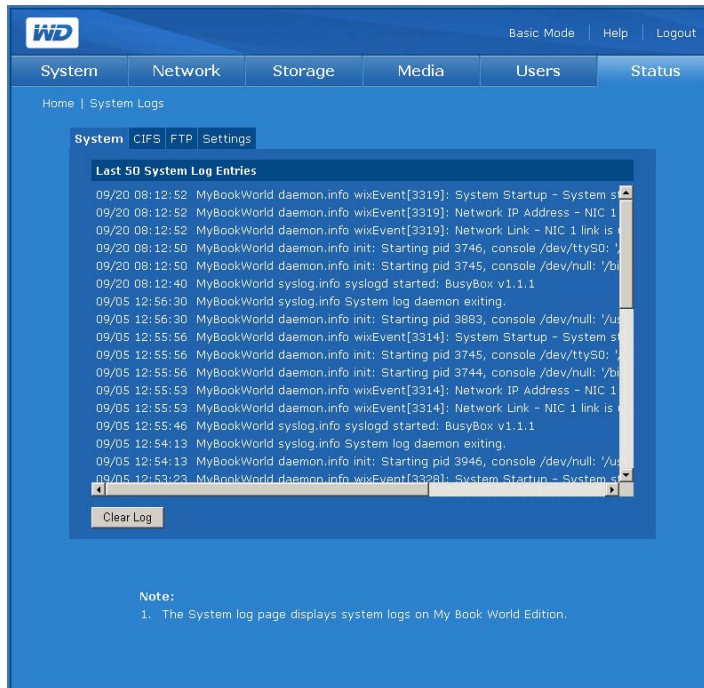

The System Logs record significant problems that occur in the system. You can obtain information from the following conditions or errors that may occur in the system components, hardware or software components.

- System shutdown
- System reboot
- Network Storage Manager utility failed to restore
- System temperature exceeds a threshold value
- Disk SMART failure
- Volume failed or does not exist
- Volume space is full or close to 100%
- Unsafe removal of a USB mass storage device
- Resync volume failed

The following types of events are logged:

- **Critical**—An event such as fan failed, system temperature has exceeded the threshold level, Disk SMART failed, volume space is full or close to 100%, extend volume failed, or resync volume failed. When a critical event occurs the power/system status LED lights up and the system record events in the System Log.
- **Warning**—An event that is not necessarily significant, but may indicate a possible future problem. An e-mail or pop-up message alert is sent to notify user of the problem that occurred in the system.
- **Information**—An event that describes the successful operation of an application, driver, or service.

**CIFS**

The **CIFS** (Common Internet File System) tab displays logs of file and services requested on the device.

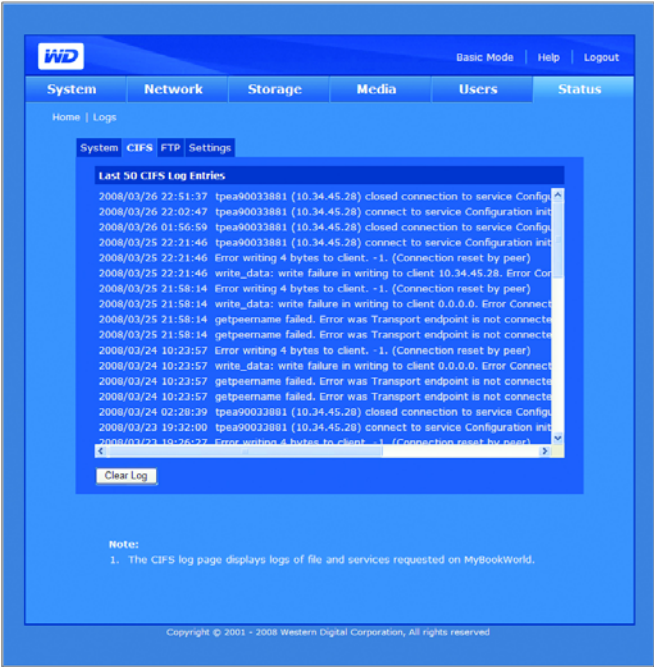

**FTP**

The **FTP** (File Transfer Protocol) tab displays logs of the requests and records transferred between the device and client computers.



## Settings

The **Settings** tab assigns the order and number of log entries that appear on the Logs page.

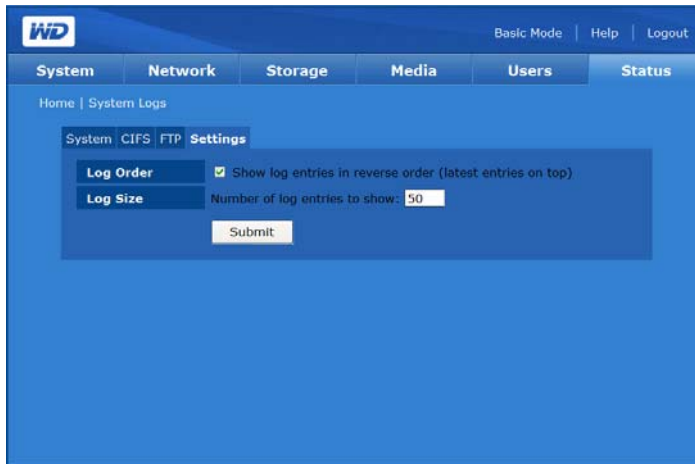

To configure the log settings:

1. On the **Settings** tab, click **Show log entries in reverse order** to display the entries in reverse chronological order.
2. Enter the number of entries you want to appear on the System, CIFS, and FTP logs.

## 11

## Accessing Data via FTP

You can access data in a shared folder on My Book World Edition using an FTP client software program. An FTP client software program must be installed on the broadband-connected computer you are using to access the device and FTP service must be enabled on the network storage system (see “To enable a network service:” on page 88 and “To modify properties of the share:” on page 98 for details).

1. Open an FTP client software program.
2. Enter ftp://username@IP address as the host name (e.g., ftp://admin@172.25.102.67) or just the device’s IP address depending on the FTP client software program you are using.



.....

*Note:* Click **System Status** in either the basic or advanced mode to view the device's IP address. For additional info, check with your internet service provider (ISP).

3. Enter the My Book World Edition user name and corresponding password.
4. Click **Connect** or **OK**.

You can now upload files to or download files from My Book World Edition across the LAN. It is possible to upload files to or download files from My Book World Edition across the internet (WAN), but this requires custom router configuration and is recommended only for advanced users.

## 12

## Scheduled Downloads

Downloader is a powerful tool for managing download tasks directly to the unit. This tool is great for when you want to download very large or multiple large files from the internet and do not want to sit and wait for the download to complete. All you have to do is identify the URL of the files you want to download from the internet and set it in the Download function on your MyBookWorld. Then you can walk away and let this tool do the rest. All the files that you want to download are saved directly to your MyBookWorld and you do not even need to have your computer on. For example, this is the ideal tool for downloading from video file sharing websites.

With a user-friendly interface, the Downloader supports multiple simultaneous downloads with various functions to manage downloads. Use Downloader to download files to a default share folder in the network storage system and share the files among many users. To use Downloader, you must set a default share folder to Download in the Network Storage Manager utility. For more information, see “To set the destination share name for the Downloader:” on page 103.

### Accessing Downloader



.....  
**Important:** To access Downloader, make sure a destination folder is properly configured in the Network Storage Manager utility. Refer to “To set the destination share name for the Downloader:” on page 103.

You can access Downloader by entering the system’s web-based user interface. See “Accessing Network Storage Manager” on page 58 for instructions.

1. In the Tools list, click **Downloader**.
2. Enter “downloader” in both the **Administrator Name** and **Password** fields and click **Login**.

## Downloader Features

Downloader includes the following features:

- Download faster with instantaneous “start”
- Simultaneous download of multiple files from the Internet
- Files are automatically stored to a preset destination folder in Network Storage Manager
- Automatically store your partially downloaded files in the database to resume downloading at any time
- Set download speed to reduce bandwidth consumption
- Schedule and queue downloads
- Resume downloading a partial download

## User Interface Overview

The Downloader user interface includes two tabs — **Tasks** and **Settings**.

### Tasks

The Tasks tab includes a table that displays the file transfer processes. The status of the file download is displayed using icons located on the File Name column and located immediately below the Submit button provides detailed information about the meaning of each status icon. The command icons located on the right-side of the tasks table allows you to add download entries, stop file download, or delete download task.

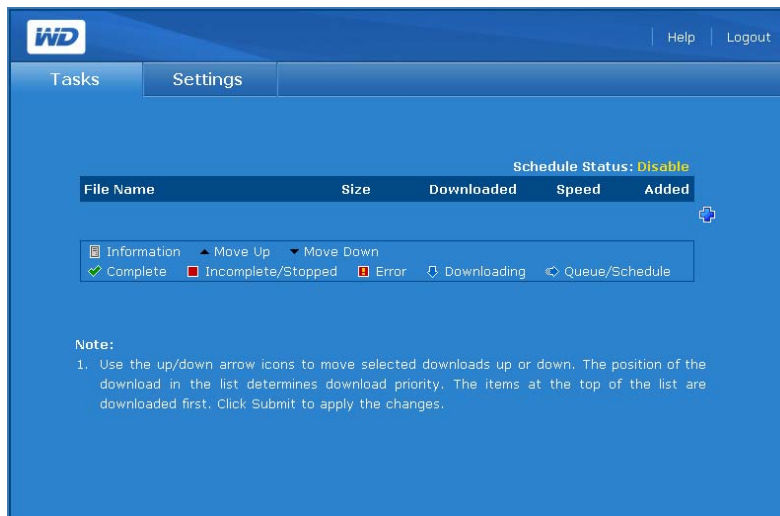

## Settings

Set the download speed and create and schedule several download queues using the **Settings** tab.

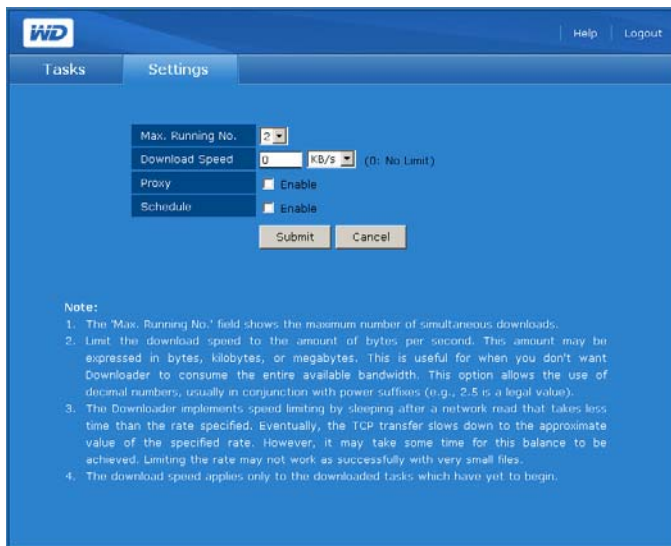

## Command icons

The Downloader Tasks tab includes the following commands:

Icon	Command	Description
	Add	Creates a download task.
	Start	Starts a specific download task.
	Stop	Ends the download task.
	Delete	Deletes download task from the table.
	Help	Displays the online guide.
	Logout	Exits the Downloader utility.



## Using Downloader

### To create a download task:

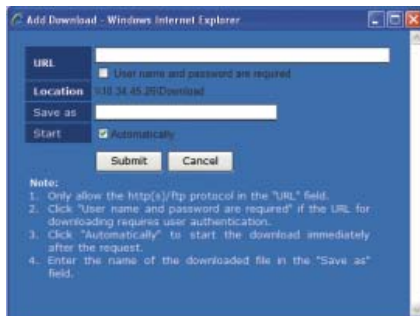
1. On the Tasks page, click Add .
2. Enter the full web address from which you want to download the file in the URL field.
3. If a user name and password is required to download the file, click **User name and password are required**, then enter the user name and password.
4. If you want to enter a new name for the file, then enter a new name in the **Save As** field.
5. Click **Automatically** to start downloading immediately after the request.
6. Click **Submit**.



### To stop and resume a download task:

1. Select a task in the Tasks table.
2. Click Stop  to stop the download task.
3. Click Start  to resume download task.

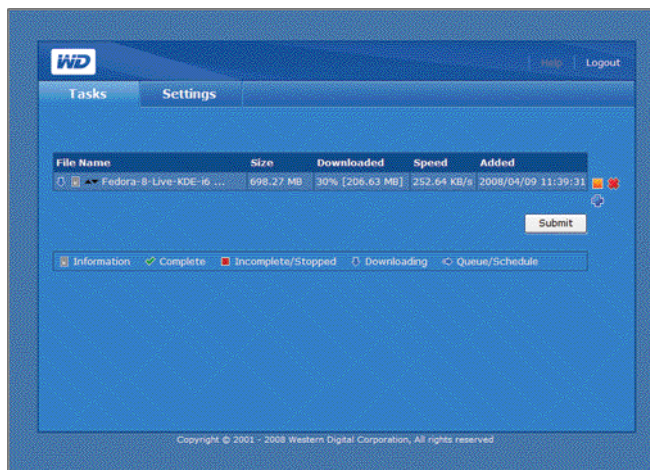

### To delete a download task:

1. Select a task in the Tasks table.
2. Click Delete  to delete the download task.
3. Click **OK**, and then click **OK** again.
4. Click **Submit**.

**To change the order of the download queue:**

1. Use the arrow buttons to change the order of download tasks or to make a task conditional on a previous task.
2. Select a task in the Tasks table, and then click Move Up ▲ or Move Down ▼.
3. Click **Submit**.

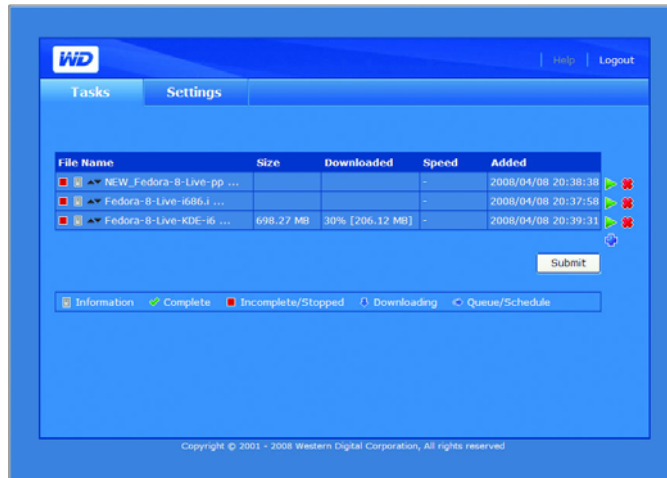

**To customize the Downloader settings:**

1. On the Downloader page, click the **Settings** tab.
2. Select a number to specify the maximum number of simultaneously running downloads in the **Max. Running No.** field.
3. Specify the decimal numbers to limit the downloaded speed if you don't want to consume the entire available bandwidth in Downloader in the **Download Speed** field.
4. Set up the proxy to download files if your network environment doesn't allow making direct connections to an external network in the **Proxy** field.
5. Click **Enable** next to **Schedule** to enable scheduled downloading time.
6. Periods of time during which downloading is allowed are indicated in yellow.
7. Click **Submit**.

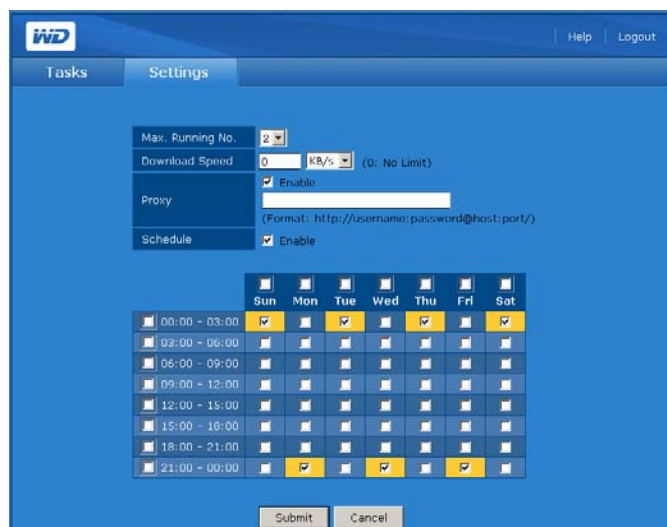

## 13

## Copy Manager

The network storage system's Copy Manager feature allows you to copy data from a USB hard drive to the network storage system or copy data from the network storage system to a USB hard drive.



.....  
**Important:** When copying data, always connect the USB hard drive directly to a USB port on the network storage system. **Do not use a USB hub.** Ensure that the destination drive has enough free space to store the amount of data being transferred.



.....  
**Important:** USB hard drives that are formatted with FAT32 are limited to copying only 4 GB for each file. If you try to transfer files that are larger than 4 GB, you may encounter a Copy Termination error.

### Connect a USB hard drive

Before using Copy Manager, be sure to connect a USB hard drive to the USB port on the rear of the network storage system. See “Connecting a USB Hard Drive” on page 46 for instructions.

### Accessing Copy Manager

You can access Copy Manager by entering the system's web-based user interface. See “Accessing Network Storage Manager” on page 58 for instructions.

1. In the **Tools** list, click **Copy Manager**.
2. Enter the administrator name and password, and then click **Login**.

Administrator Name	admin
Password	*****
Tool	Copy Manager
Language	English

Login

## NAS to USB Copy

The default operation for the Copy Manager is NAS to USB Copy.

1. Browse to the source folder in the **Source Folder Selection** list or enter the path manually. Click **Next**.

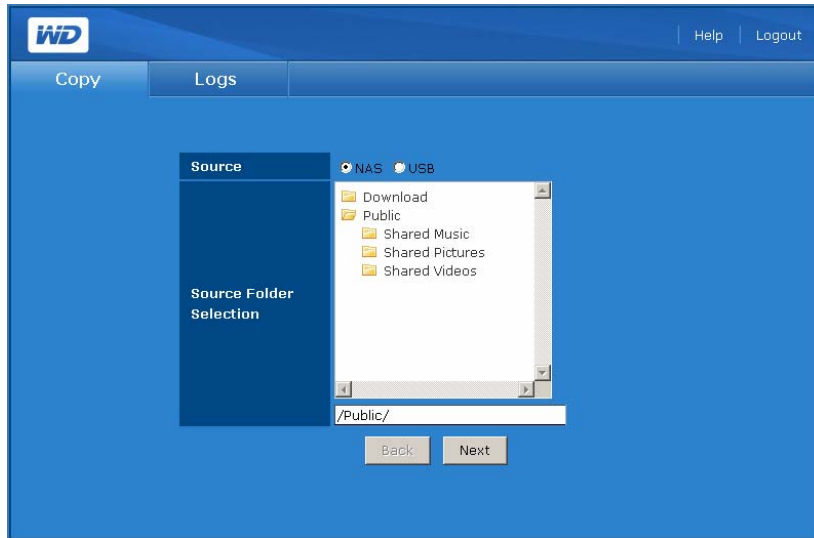

2. Browse to the destination folder in the **Destination Folder Selection** list or enter the path manually. Click **Next**.

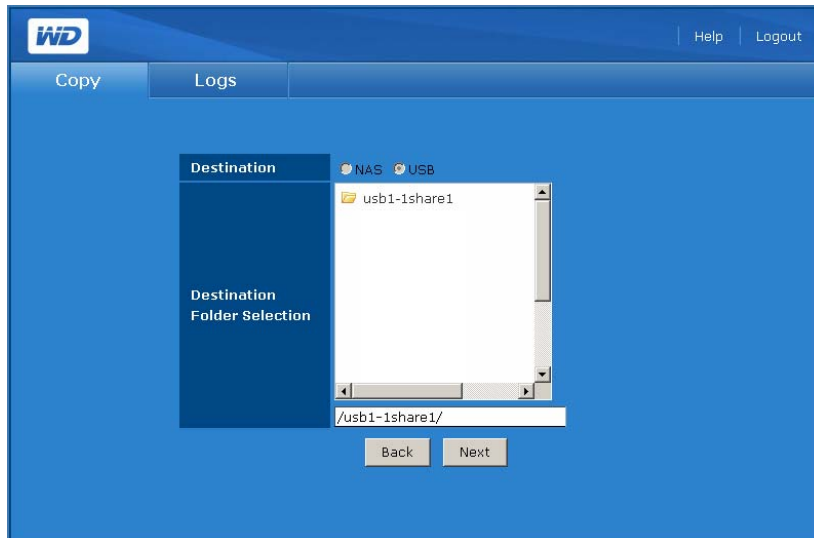

3. Click **Start**.

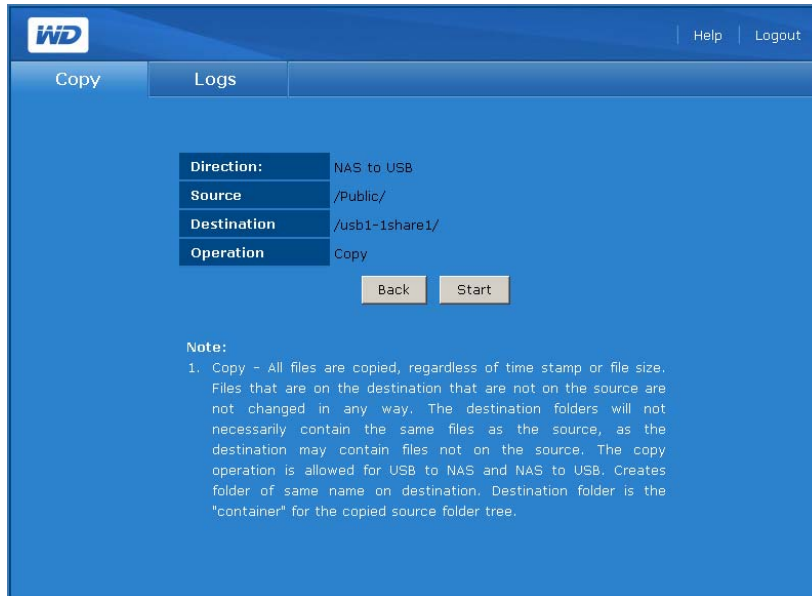

4. Click **OK**. Any file on the destination drive with the same name as a file on the source drive will be overwritten.

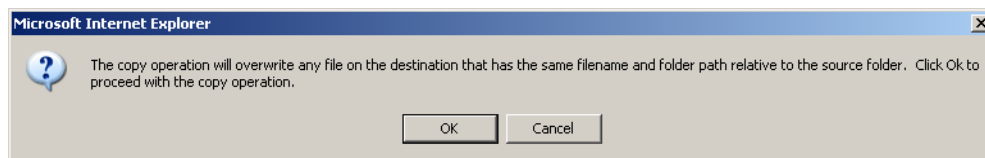

## USB to NAS Copy

1. Click **USB**. Browse to the source folder in the **Source Folder Selection** list or enter the path manually. Click **Next**.

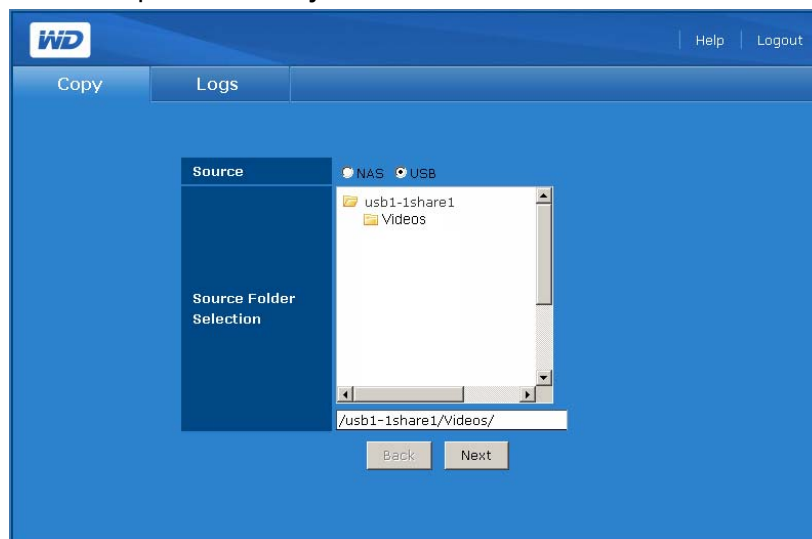

2. Browse to the destination folder in the **Destination Folder Selection** list or enter the path manually. Click **Next**.

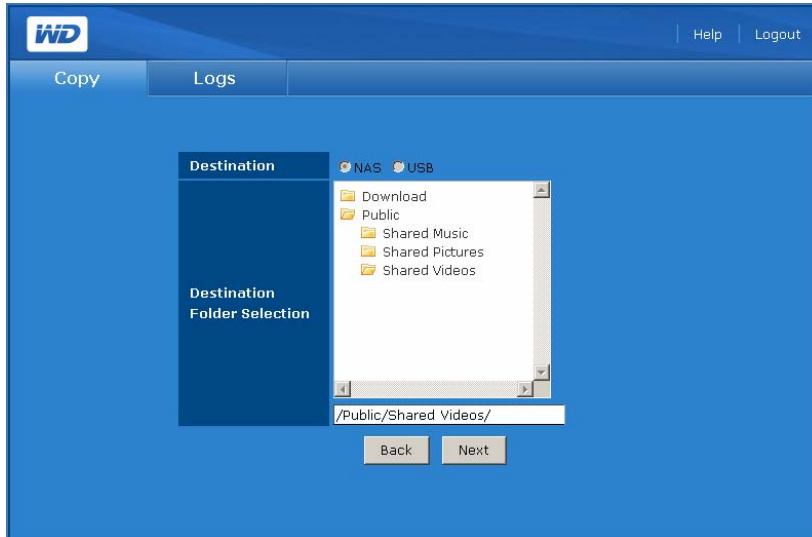

3. Click **Start**.



4. Click **OK**. Any file on the destination drive with the same name as a file on the source drive will be overwritten.

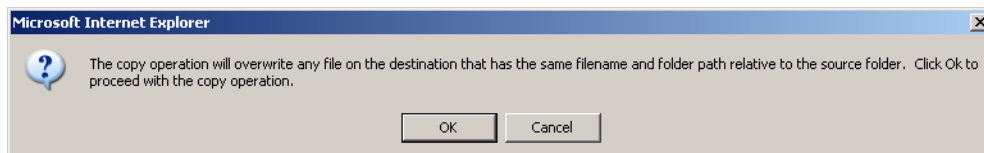

5. The copy operation begins. Click **Stop** if you wish to stop the copy.

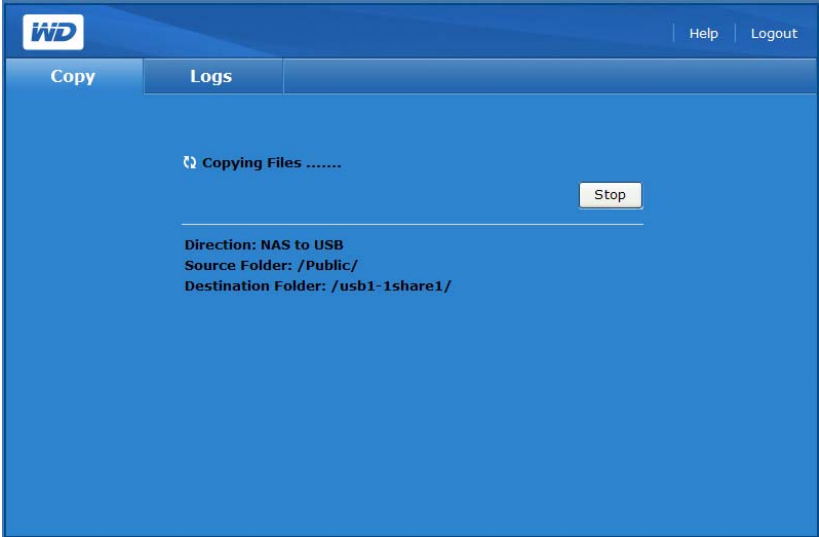

6. Click **OK**.

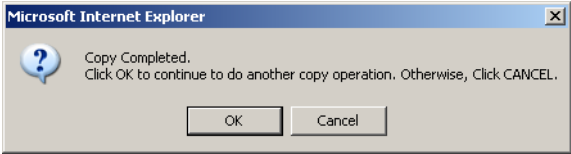

## 14

## Replacing a Drive (My Book World Edition II)

My Book World Edition II is a limited user-serviceable product which allows for servicing of one or both internal hard drives in the enclosure.



**Important:** Only WD Caviar® Green™ hard drive assemblies can be inserted into the My Book World Edition enclosure.

If the LEDs on the unit are flashing, a network drive may be faulty. To determine which drive is faulty, do the following:

1. Open WD Discovery and select the unit.
2. Click **Configure** and log in.
3. Click the **Advanced** view and then click the **Storage** tab.
4. Click the **Disk Management** button.

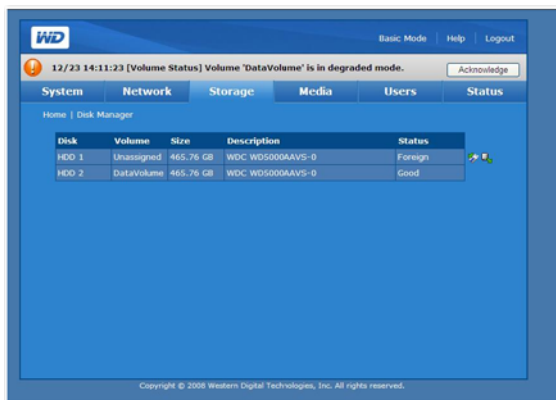

The “Unassigned” drive is the defective one. The number corresponds to the A or B color coded decal on the drive, as shown on the next page.

In the event a fault occurs and you would like to service the device yourself, visit WD Technical Support at [support.wdc.com](http://support.wdc.com) and search the knowledge base article 1709 for detailed instructions on obtaining a replacement drive. When contacting Technical Support, have the following items ready: My Book serial number, date of purchase, and the serial number of the internal hard drive(s) which require replacement. Once you have received the replacement drive(s), follow the steps below to service the dual-drive storage system.



**Important:** To avoid electrostatic discharge (ESD) problems, ground yourself by touching the metal chassis of the computer before handling the device.

Before getting started, power off the unit and disconnect all of its cables.

1. Place the unit on a clean and stable surface

- Using your thumb, firmly push down on the top front panel of the unit to release the latch and open the cover.

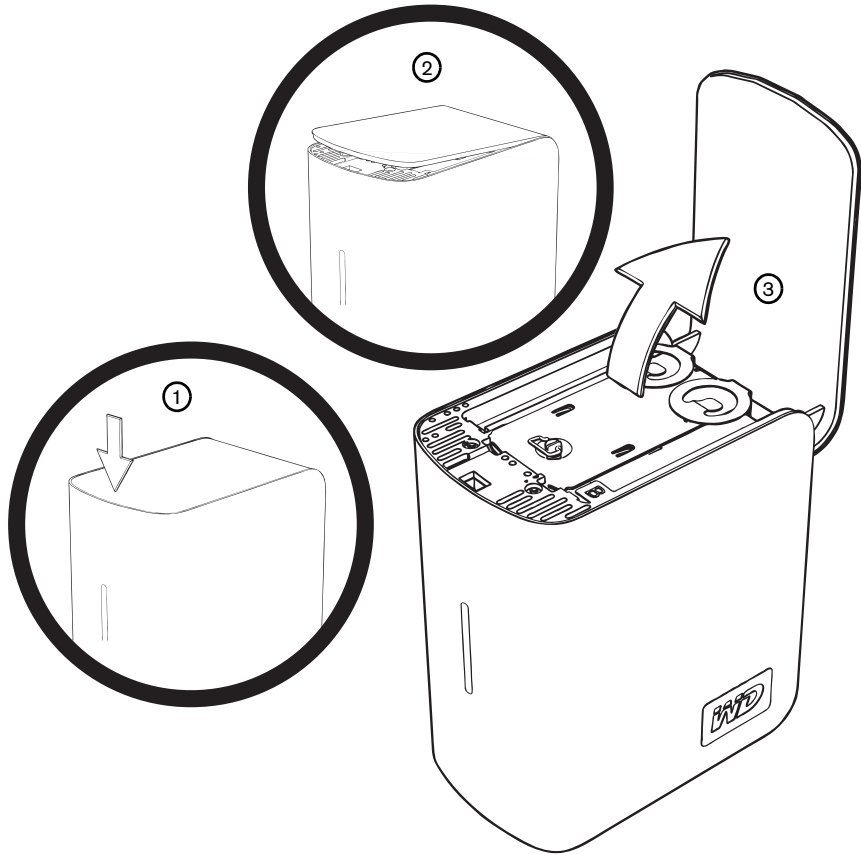

- Loosen the thumbscrew that secures the drive cover plate. Remove the drive cover plate and set aside.

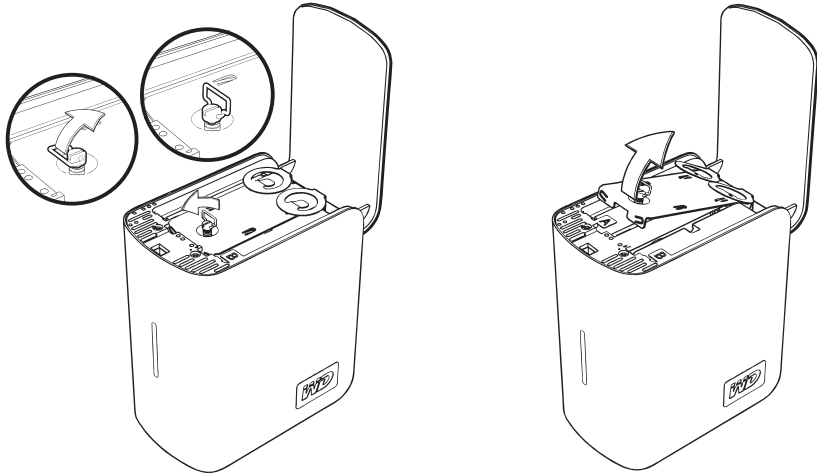

 .....  
*Note:* Each drive is designated A or B by a color coded decal.

4. Locate the drive you wish to replace (A or B). Using the pulltab, carefully and slowly pull the drive assembly up and out of the enclosure and set aside.

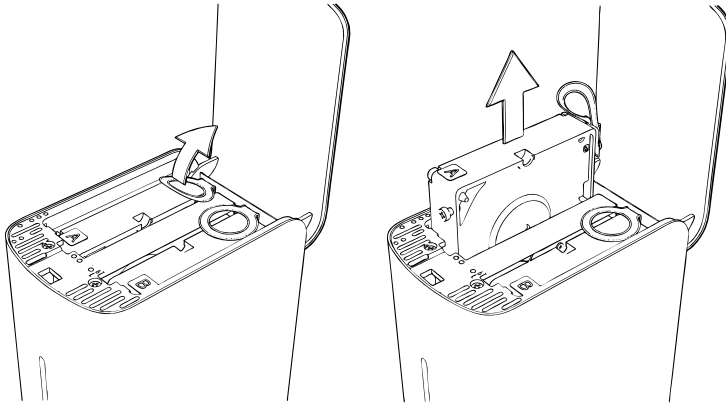

5. Gently slide the replacement drive assembly into the drive slot until it is fully inserted.

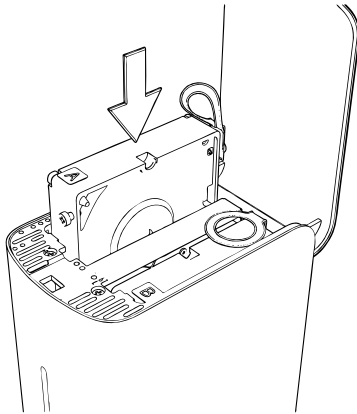

6. Replace the cover plate by sliding it under and between the pulltabs and securing it with the thumbscrew.



.....  
*Note:* Do not overtighten the thumbscrew.

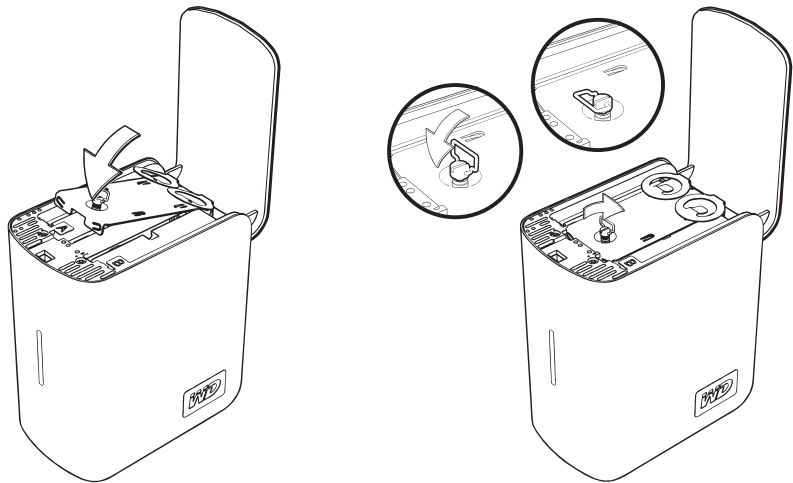

7. Close the cover and firmly push down until it locks into place.

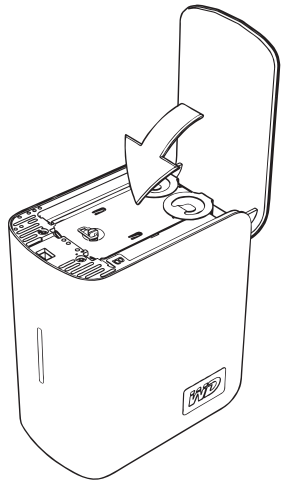

- 8. Reconnect only the power cable to the device. Do not connect computer interface cables.
- 9. The drive starts the rebuild process automatically and the LEDs cycle from bottom to top. The RAID rebuild may take up to 12 hours depending on drive capacity and activity, but typically will complete in 5-7 hours. Allow the RAID rebuild to complete.



.....  
**Important:** Do not attempt to use the device during the rebuild process.

- 10. Once complete, the LEDs will glow steadily to indicate power-on state.
- 11. Connect the interface cable.
- 12. Return the faulty drive following the instructions provided in the WD knowledge base article# 1709.



.....  
**Important:** Do not disassemble the internal drive and attached assembly components. Return the entire internal drive assembly intact to WD.

## 15

## Troubleshooting

For any issue, first ensure that you are using the latest firmware for My Book World Edition. The latest firmware includes the latest network and SATA disk drivers. See “Update (Firmware)” on page 77 for instructions.

### First steps checklist

- AC power available at the wall outlet?
- Are the power supplies plugged in? Check the AC cable(s) on the back of the chassis and at the AC source.
- Are all cables correctly connected and secured?
- Are all peripheral devices installed correctly?
- Are all device drivers properly installed?
- Did you press the power button on the front panel to turn the device on (power indicator should be lit)?
- Is the power cord properly connected to the device and plugged into an outlet for 100-127 V or 200-240 V?

### Resetting the network storage system

#### To reset the system using the reset button:

If you have forgotten your password, or if the network is misconfigured, pressing the reset button while the device is powered up resets the admin user name and password and IP settings to the default values without erasing shared folders or volumes. Follow the instructions below to reset the device using the recovery button.

1. With the device powered on, insert a paperclip or narrow tipped pen into the reset button slot on the back of the unit.
2. Press and hold down the reset button for four seconds. The device reboots (this may take up to three minutes).

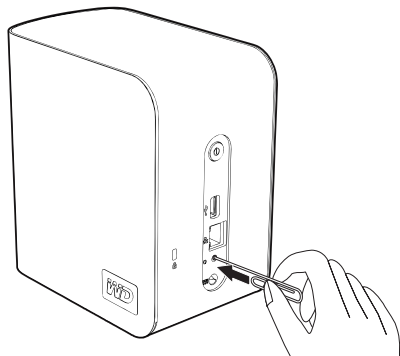

.....  
*Note:* The default user name and password is **admin**.

#### To reset the system to factory default settings:

Performing a factory default reset using the Network Storage Manager erases all settings, shares, and data files in the network storage system. All information and data is lost. For detailed instructions, see “To restore the device to factory defaults:” on page 81.

## Hardware diagnostic testing

This section provides a detailed approach to identifying a hardware problem and locating its source.



.....

**CAUTION!** Before disconnecting any peripheral cables from the system, turn off the network storage system and any external peripheral devices. Failure to do so can cause permanent damage to the network storage system and/or the peripheral device.

1. Turn off the network storage system and all external peripheral devices.
2. Make sure the power cord is plugged into a properly grounded AC outlet.
3. Turn on the device. If the power indicator on the front panel does not light, see *“LEDs do not light up.”* on page 133.

### Specific problems and corrective actions

The following contains specific problems that may arise during the use of the network storage system. Possible solutions are listed for each problem.

#### **LEDs do not light up.**

Do the following:

- Make sure the power button on the rear of the device is turned on.
- Make sure the power cord is connected correctly.
- Make sure that the wall outlet has power. Test it by plugging in another device.

#### **Can I back up all data from a USB hard drive with multiple partitions to the device?**

No. Only data stored on the first partition of the USB hard drive is backed up to the network storage system. System cannot connect to a network and network status indicator does not light.

- Make sure the network cable is securely attached to the correct connector on the rear panel of the device.
- Try a different network cable.
- Make sure switch or router has power.

Do the following:

- Check the cabling and network equipment to make sure that all cables are properly connected.
- Try another port on the router or switch.

#### **The Network Storage Manager does not appear when I click Configure in WD Discovery.**

Make sure JavaScript is enabled in your browser. See your browser's Help menu for instructions.

**I received a banner warning message, email alert, or pop-up screen indicating a failed volume.**

Do the following:

1. Verify hard drive status in the Disk Manager submenu. See “Disk Manager” on page 92. If the status of any drive is “Failed,” visit WD Technical Support at [support.wdc.com](http://support.wdc.com) and search the knowledge base article 2569 for detailed instructions on obtaining a replacement drive.
2. If Disk Manager does not indicate that a hard drive has failed, power cycle the device.
3. If the volume that failed is a new volume, try rebuilding the RAID array. See “Manage RAID (My Book World Edition II)” on page 94 for details. If this does not resolve the problem, visit WD Technical Support at [support.wdc.com](http://support.wdc.com) and search the knowledge base article 2569 for detailed instructions on obtaining a replacement drive.

**My router has failed or is not available. How do I access my data in the device?**

Do the following:

1. Connect the device directly to the computer's Ethernet port.

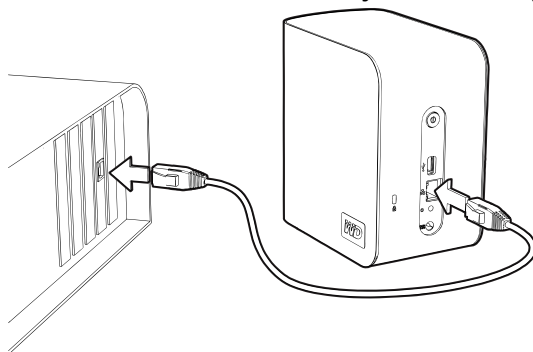

2. Launch WD Discovery Tool and see “Mapping a Network Drive” on page 47 for instructions on how to access data in the device.

**I received the message “iTunes server cannot find the path to /Public/Shared Music” or am having problems sharing photos or video.**

The iTunes server service requires the presence of the ‘/Public/Shared Music’ share folder. Do not rename or delete Shared Music if you want to use the iTunes server. You must recreate or rename the ‘/Public/Shared Music’ share if it has been deleted or renamed. Renaming or deleting any of the default shares (Shared Music, Shared Photos, or Shared Videos) could result in file sharing disruption.

**I cannot start WD Discovery to access the configure feature.**

Do the following:

1. Click **Start > Run**.
2. Type \\mybookworld, and then click **OK** (if the device name was changed, type \\yournewdevicename).
3. The My Book World Edition directory displays (Public, Configuration, and Download folders). Double-click the Configuration folder.
4. Double-click index.html. The configuration login screen displays.

**My router has failed or is unavailable as well as the WD Discovery Tool. How do I access my data in the device? (Windows XP)**

Do the following:

1. Connect the device directly to the computer's Ethernet port.
2. Double-click **My Computer**.
3. Click **My Network Places**.
4. On the **Tools** menu, point to **Map Network Drive**.
5. Leave the default drive set to Z.
6. In the **Folder** drop-down list, select \\device name\public.

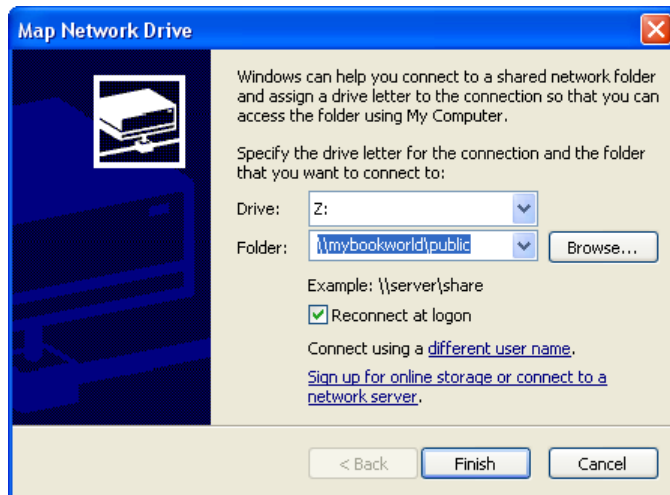

7. Click the **Finish** button.
8. Go back to the opening window of **My Computer** to view the public folder of your device under **Network Drives**.

**I am unable to play music, videos and/or view pictures through my digital media adapter.**

The media server has by default been set up to scan your My Book World Edition for media content that you have added.

First, make sure that you have sorted and added your media content to the corresponding shared folders (e.g., music files must go into the Shared Music folders). If you do not do this, your content will not display.

Because there are many kinds of file formats for pictures, videos and music, your particular digital media adapter may not support a format to play or display it. Depending on the digital media adapter device (for example, Xbox, PS3, Windows, and Media Center) that you have, you may need to update your device with the proper CODECs to support the media format that you want to play. Please refer to your digital media adapter's user manual for further information of how to locate and update CODECs.

## System Events

The following table describes the event types that are recorded in the system log.

Event type and ID	State	Value	Critical	Warning
<b>System events</b>				
Startup	[none]			
Abnormal Shutdown	[none]			✓
Shutdown	[none]			✓
Reboot	[none]			✓
Software Update	Succeeded	Version		
Software Update	Failed			✓
Factory Default	Succeeded			
<b>Thermal events</b>				
Thermal 1	Normal	Degrees		
Thermal 1	Exceeded the threshold (Overheated)	Degrees	✓	✓
<b>HDD SMART events</b>				
HDD [1,2]	HDD SMART OK			
HDD [1,2]	HDD SMART fail		✓	✓
<b>Volume events</b>				
Volume	Sent if volume could not be recovered		✓	✓
Volume	Volume doesn't exist		✓	✓
Volume	Volume created			✓
Volume	Volume deleted			✓
Volume	Volume modified			
<b>Volume events (My Book World Edition II)</b>				
Volume	RAID volume in normal mode			
Volume (Span)	Volume Extend Failed		✓	✓
Volume	Volume Resync Failed		✓	✓
Volume (RAID 1)	RAID volume in degraded mode		✓	✓
Volume (RAID 1)	RAID volume resyncing	Progress		✓
<b>Volume usage events</b>				
Volume [1,2]	Volume has 25~100% free capacity			
Volume [1,2]	Volume has more than 10% free capacity			
Volume [1,2]	Volume has more than 5% free capacity			
Volume [1,2]	Volume has reached 80% capacity			✓
Volume [1,2]	Volume has reached 95% capacity		✓	✓

Event type and ID	State	Value	Critical	Warning
Volume [1,2]	Volume has reached full capacity		✓	✓
Volume [1,2]	Volume had NOT been mounted			
<b>Network events</b>				
LAN 1	Link Ok	Speed (Mbps: 1000/100/ 10)		
LAN 1	Link down			✓
LAN 1	Use dynamic IP address got from DHCP	IP address		
LAN 1	Can not get IP address from DHCP, use default	IP address		
LAN 1	Cannot get IP address from DHCP server, use zeroconf.	IP address		
<b>USB events</b>				
USB [1]	Copy Manager did not finish because external drive is full		✓	✓
USB [1]	USB disk insertion			
USB [1]	USB disk safely removed			
USB [1]	USB disk unsafely removed			✓
USB [1]	USB disk format OK			
USB [1]	USB disk format fail		✓	✓
<b>User events</b>				
[User ID]	User quota is normal			
[User ID]	User quota reached 90%			
[User ID]	User quota is full			✓
[User ID]	User created			
[User ID]	User deleted			
[User ID]	User modified			
<b>Group events</b>				
[Group ID]	Group created			
[Group ID]	Group deleted			✓
[Group ID]	Group modified			
<b>Other events</b>				
Volume [1,2]	Volume extend failed		✓	✓
Volume [1,2]	Volume resync failed		✓	✓

## Appendix

### Regulatory Compliance

#### FCC Class B Information

This device has been tested and found to comply with the limits of a Class B digital device, pursuant to Part 15 of the FCC Rules. These limits are designed to provide reasonable protection against harmful interference in a residential installation. This unit generates, uses, and can radiate radio frequency energy and, if not installed and used in accordance with the instructions, may cause harmful interference to radio or television reception. However, there is no guarantee that interference will not occur in a particular installation. Any changes or modifications not expressly approved by WD could void the user's authority to operate this equipment.

The following booklet, prepared by the Federal Communications Commission, may be helpful: *How to Identify and Resolve Radio/TV Interference Problems*. This booklet is Stock No. 004-000-00345-4 available from the US Government Printing Office, Washington, DC 20402.

The provided Ethernet cable must be used between the unit and network connection to comply with FCC Part 15 Class B and EN-55022 Class B.

#### ICES/NMB-003 Compliance

Cet appareil de la classe B est conforme à la norme NMB-003 du Canada.

This device complies with Canadian ICES-003 Class B.

#### Safety Compliance

Approved for US and Canada. CAN/CSA-C22.2 No. 60950-1, UL 60950-1: Safety of Information Technology Equipment.

Approuvé pour les Etats-Unis et le Canada. CAN/CSA-C22.2 No. 60950-1 : Sûreté d'équipement de technologie de l'information.

This product is intended to be supplied by a listed limited power source, double insulated, or direct plug-in power unit marked "Class 2."

#### CE Compliance for Europe

Verified to comply with EN55022 for RF emission; EN-55024 for Generic Immunity, as applicable; and EN-60950 for Safety.

## Environmental Compliance (China)

部件类型	元素					
	PB	Hg	Cd	Cr VI	PBB	PBDE
PCB	o	o	o	o	o	o
底盘 (外壳+页面)	o	o	o	o	o	o
机械装配 (HDD 托架+EMI)	o	o	o	o	o	o
处理器模块 Oxford SOC	o	o	o	o	o	o
电池	X	o	o	o	o	o
存储设备: HDD	X	o	o	o	o	o

o: 标识产品不含或含量低于国家强制性标准限值。MCV 类产品在欧盟注册。

X: 标识产品不含或含量低于国家强制性标准限值。MCV 类产品在欧盟注册。但欧盟 I 类。X: 标识产品符合 -WD 环保标准。

## Warranty Information

### Obtaining Service

WD values your business and always attempts to provide you the very best of service. If this Product requires maintenance, either contact the dealer from whom you originally purchased the Product or visit our product support website at [support.wdc.com](http://support.wdc.com) for information on how to obtain service or a Return Material Authorization (RMA). If it is determined that the Product may be defective, you will be given an RMA number and instructions for Product return. An unauthorized return (i.e., one for which an RMA number has not been issued) will be returned to you at your expense. Authorized returns must be shipped in an approved shipping container, prepaid and insured, to the address provided on your return paperwork. Your original box and packaging materials should be kept for storing or shipping your WD product. To conclusively establish the period of warranty, check the warranty expiration (serial number required) via [support.wdc.com](http://support.wdc.com). WD shall have no liability for lost data regardless of the cause, recovery of lost data, or data contained in any Product placed in its possession.

### Limited Warranty

WD warrants that the Product, in the course of its normal use, will be free from defects in material and workmanship for a period of three (3) years, unless otherwise required by law, and will conform to WD's specification therefor. This limited warranty period shall commence on the purchase date appearing on your purchase receipt. WD shall have no liability for any Product returned if WD determines that the Product was stolen from WD or that the asserted defect a) is not present, b) cannot reasonably be rectified because of damage occurring before WD receives the Product, or c) is attributable to misuse, improper installation, alteration (including removing or obliterating labels and opening or removing external enclosures, including the mounting frame, unless the product is on the list of limited user-serviceable products and the specific alteration is within the scope of the applicable instructions, as found at [support.wdc.com](http://support.wdc.com)), accident or mishandling while in the possession of someone other than WD. Subject to the limitations specified above, your sole and exclusive warranty shall be, during the period of warranty specified above and at WD's option, the repair or replacement of the Product. The foregoing warranty of WD shall extend to repaired or replaced Products for the balance of the

applicable period of the original warranty or ninety (90) days from the date of shipment of a repaired or replaced Product, whichever is longer.

The foregoing limited warranty is WD's sole warranty and is applicable only to products sold as new. The remedies provided herein are in lieu of a) any and all other remedies and warranties, whether expressed, implied or statutory, including but not limited to, any implied warranty of merchantability or fitness for a particular purpose, and b) any and all obligations and liabilities of WD for damages including, but not limited to accidental, consequential, or special damages, or any financial loss, lost profits or expenses, or lost data arising out of or in connection with the purchase, use, or performance of the Product, even if WD has been advised of the possibility of such damages. In the United States, some states do not allow exclusion or limitations of incidental or consequential damages, so the limitations above may not apply to you. This warranty gives you specific legal rights, and you may also have other rights which vary from state to state.

### **GNU General Public License (“GPL”)**

Firmware incorporated into My Book World Edition includes third party copyrighted software licensed under the GPL (“GPL Software”). In accordance with the GPL: 1) the source code for the GPL Software may be obtained at [support.wdc.com/download/gpl](http://support.wdc.com/download/gpl); 2) you may re-use, re-distribute and modify the GPL Software; 3) with respect solely to the GPL Software, it is provided “as is” without warranty of any kind, either expressed or implied, including, but not limited to, the implied warranties of merchantability and fitness for a particular purpose, to the extent permitted by applicable law; and 4) a copy of the GPL is included on the enclosed CD, may be obtained at [www.gnu.org](http://www.gnu.org), and may also be found at [support.wdc.com/download/gpl](http://support.wdc.com/download/gpl).

## WD Service and Support

If you need additional information or help during installation or normal use of this product, visit our product support website at [support.wdc.com](http://support.wdc.com) and choose from these topics:

- **Warranty Services** — Obtain warranty information, warranty status, extended warranty, product replacement, RMA status, and shipping and packaging information.
- **Downloads Library** — Download installation software and drivers.
- **Technical Information** — Access product specifications, technical tips, and the online forum.
- **Knowledge Base** — Explore our expert knowledge base and Frequently Asked Questions.
- **Service Partners** — Find available WD-approved service and support in your region.
- **Contact Support** — Contact a support representative by e-mail.
- **Rebates** — Check the status of rebate submissions.
- **Localized Support** — Display service and support information in various languages.

When contacting WD for support, have your WD product serial number, system hardware, and system software versions available.

[support.wdc.com](http://support.wdc.com)  
[www.westerndigital.com](http://www.westerndigital.com)

800.ASK.4WDC	North America
800.832.4778	Latin America (Spanish)
+800.6008.6008	Asia Pacific
+800.ASK.4WDEU	Europe (toll free where available)
+31.88.0062100	Europe, Middle East, Africa

Western Digital  
20511 Lake Forest Drive  
Lake Forest, California 92630 U.S.A.

---

Information furnished by WD is believed to be accurate and reliable; however, no responsibility is assumed by WD for its use nor for any infringement of patents or other rights of third parties which may result from its use. No license is granted by implication or otherwise under any patent or patent rights of WD. WD reserves the right to change specifications at any time without notice.

Western Digital, WD, the WD logo, My Book, WD Caviar and MioNet are registered trademarks in the U.S. and other countries; and World Edition, Green, and WD Discovery are trademarks of Western Digital Technologies, Inc. Other marks may be mentioned herein that belong to other companies.

© 2008 Western Digital Technologies, Inc. All rights reserved.

4779-705013-A00 Dec 2008

# Index

## A

- admin login password
  - change 72
- audio
  - streaming in iTunes 40, 102

## B

- Backup
  - to NAS 122
  - to USB 121

## C

- Capacity gauge 9
- CE compliance 134
- change password
  - downloader 100
- China RoHS 135
- Compliance, regulatory 134
- configuration menu 75
- Copy Manager 120
  - accessing 120

## D

- date & time 59
- destination share
  - setup 99
- device name 59
- disk manager 88
- domain
  - set 85
- download queue
  - change order 118
- download task
  - create 117
- Downloader 114
  - accessing 114
  - command icons 117
  - features 114
  - UI overview 116
  - using 117
- Downloader destination share
  - setup 99
- Downloader password
  - change 100
- Downloader settings
  - configure 119
- downloads menu 99

## E

- e-mail notifications
  - setup 70
- Environmental compliance (China) 135
- Europe, CE compliance 134

## F

- FCC Class B information 134
- features
  - ports 7
  - reset button 7
  - security slot 8
- file sharing protocols 94
- firmware update 73
- folder share permissions 106
- folder shares 93
- FTP
  - accessing data 113
- FTP logs 111

## G

- general setup 69
- general setup settings
  - configure 69
- getting started 3
- GNU general public license 136
- GPL software 136
- group account
  - create 105
  - delete 106
  - modify 106
- group accounts
  - assign access rights 107

## H

- hardware setup
  - connect the system 10
- HDD standby
  - enable 79

## I

- ICES/NMB-003 compliance 134
- Indicators 9
- indicators 9
- introduction 2
- iTunes server service 101
  - enable 102
  - streaming audio 40, 102

## K

kit contents 4

## L

LAN submenu 82

LED control

enable 80

LED indicators 9

capacity gauge 9

Limited warranty 135

log settings

configure 112

logs

FTP 111

settings 112

system 109

## M

Macintosh software update 2

manage RAID 90

configure 91

options 91

manage volume 89

media 100

iTunes 101

Media server 100

## N

network 81

LAN 82

services 83

workgroup setup 84

network drive

mapping 43

network mode 60

network service

enabling 84

network settings configuration 82

Network Storage Manager 49

accessing 54

Mac 54

using Windows 54

advanced mode 67

basic mode 58

features 55

media tab 100

network tab 81

status tab 109

storage tab 87

system tab 68

toolbar 56

UI overview 56

users tab 103

using 49

Network storage system

using 125

## O

Obtaining service 135

Operating system, updating 2

## P

permissions

folder share 106

USB share 108

pop-up message alert

setup 71

ports 7

power button 8

pre-installation requirements 5

Product registration 1

## Q

quota

configure 97

## R

RAID levels 90

RAID management 89

RAID options 91

reboot 65

Recovery button 128

Registration, product 1

Regulatory compliance 134

reset button 7

restore 75

system to factory defaults 77

RoHS 135

RSA key

generate 79

## S

Safety compliance 134

safety instructions 2

scheduled downloads

creating 114, 120

security slot 8

Service packs 2

Service, WD 135, 137

share

access data 46

using WD Discovery 46

- create 63, 94
- delete 64
- shares 93
  - browse 46
- shortcut creation 48
- shutdown 65
- shutdown/reboot 65
- Software, GPL 136
- specifications 3
- SSH
  - enable 78
- SSL certificate
  - generate 79
- status 109
  - logs
    - CIFS 111
    - FTP 111
    - settings 112
  - system status 109
- storage 87
  - disk manager 88
  - downloads 99, 100
    - change password 100
    - setup destination share 99
  - folder shares 93
  - quota 96, 98
    - datavolume user quota 98
    - manage quota 96
    - user 98
  - usb shares 95
    - usb disk 95
  - volumes 89
    - manage RAID 90, 89
  - volumes and RAID management 89
- Support, WD 137
- system 68
  - admin password 72
  - advanced 77
  - alerts setup 70
  - configuration 75
  - general setup 69
  - remote access 86
  - restart 80
  - restore 75
  - update firmware 73
- system configuration settings
  - restore 76
  - save 76
- system events specification 132
- system logs 109
- system logs records
  - event type 110
  - system conditions or error 110

- system requirements 5
- system status 64, 109
- system tour 7
  - LED indicators 9
- system view 7

## T

- troubleshooting 128
  - checklist 128
  - hardware diagnostic testing 129
  - problems 129
    - backup from USB with multiple partitions 129
    - cannot connect to a network 129
    - LAN LED no light 129
    - no video 129
  - resetting the system 128
- Twonky Media server 100

## U

- UL 134
- Underwriters Laboratories Inc. 134
- Updating, operating system 2
- UPnP NAT Traversal
  - enabling 84
- USB Disk tab 95
- USB hard drive
  - connect 120
  - disconnect 96
  - format 95
- USB share
  - assign access rights 108
- USB share permissions 108
- user account
  - assign privilege 107
  - create 61, 103
  - delete 104
  - modify 104
- user quota 98
  - modify 98
- users
  - folder shares 106
  - groups 105
  - usb shares 108
- users tab 103

## V

- volumes 89

## W

- Warranty 135
- Warranty, limited 135
- WD

service 137  
support 137  
WD Discovery  
    browse network shares 46  
    desktop shortcut creation 48  
WD ShareSpace  
    using  
        access data 46  
Windows, updating 2  
workgroup  
    create 85  
workgroup menu 84